

KENWOOD

144MHz FM TRANSCEIVER

TM-231A/231E

220MHz FM TRANSCEIVER

TM-331A

440/430MHz FM TRANSCEIVER

TM-431A/431E

1200MHz FM TRANSCEIVER

TM-531A/531E

INSTRUCTION MANUAL

KENWOOD CORPORATION

www.r6-ru4montesecchieta.it

IZ5CCV

© PRINTED IN JAPAN B50-8286-20(K, M, W, T)(T)
90/12 11 10 9 8 7 6 5 4 3 2 1 89/12 11 10 9 8 7 6

Thank you for purchasing this new transceiver.

IMPORTANT:
Please read this instruction manual carefully before placing your transceiver in service.

SAVE THIS INSTRUCTION MANUAL.

CAUTION:
Long transmission or extended operation in the HI power mode might cause the rear of this transceiver to get warm. Do not place the transceiver where the heat sink (rear panel) might come in contact with plastic or vinyl surfaces.

This Instruction Manual covers the following models.

- TM-231A : 144 MHz FM transceiver
(U.S.A. and general markets)
- TM-231E : 144 MHz FM transceiver
(U.K. and European markets)
- TM-331A : 220 MHz FM transceiver (U.S.A. only)
- TM-431A : 430 MHz FM transceiver
(General market)
- TM-431A : 440 MHz FM transceiver (U.S.A. only)
- TM-431E : 430 MHz FM transceiver
(U.K. and European markets)
- TM-531A : 1200 MHz FM transceiver (U.S.A. only)
- TM-531E : 1200 MHz FM transceiver
(European market)

The following explicit definitions apply in this manual:

- Note** : If disregarded, inconvenience only, no risk of equipment damage or personal injury.
- Caution** : Equipment damage may occur, but not personal injury.

CONTENTS

- 1. BEFORE OPERATION 3
- 2. SPECIFICATIONS and ACCESSORIES 5
- 3. INSTALLATION INSTRUCTIONS 6
- 4. OPERATION
 - OPERATING CONTROLS 9
 - RECEIVER OPERATION.....15
 - Reception
 - Frequency Selection
 - Frequency Step Selection16
 - Programable VFO17
 - ALT19
 - TRANSMITTER OPERATION20
 - MEMORY.....21
 - Microprocessor Memory Back-up
 - Microprocessor Initialization
 - Memory Channel
 - Memory Contents
 - Memory Entry22
 - Memory Recall24
 - Memory Shift
 - SCAN25
 - Scan Operation
 - Hold/Resume Programming
 - Band Scan
 - Programmable Band Scan26
 - Memory Channel Scan
 - Memory Channel Lockout

Priority Alert Function	27
REPEATER OPERATION	28
Transmitter Offsets	
Reverse Function	
Tone and CTCSS Operation	
Autopatch Operation	29
TONE ALERT SYSTEM	30
DIGITAL RECORDING SYSTEM	31
Tone Quality Level Selection	
Maximum Recording Phrase Selection	
Recording	33
Play Back	34
Automatic Recording	
5. BLOCK DIAGRAM and	
SCHEMATIC DIAGRAM	another sheet
6. MAINTENANCE	35
In Case of Difficulty	36
7. OPTIONAL ACCESSORIES	
CTCSS unit TSU-6	37
Digital Recording Unit DRU-1	
Remote Controller RC-10	

1. **WARNING** BEFORE OPERATION

TO PREVENT ELECTRIC SHOCK, FIRE AND OTHER INJURY. PLEASE NOTE THE FOLLOWINGS:

To avoid risk of electric shock, under no circumstances should the unit be opened.

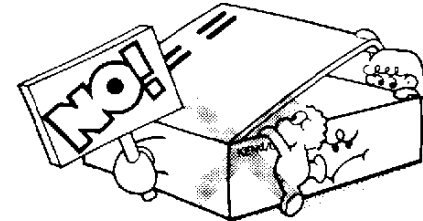

Do not place this unit, where it will be exposed to direct sunlight or close to heating appliances.

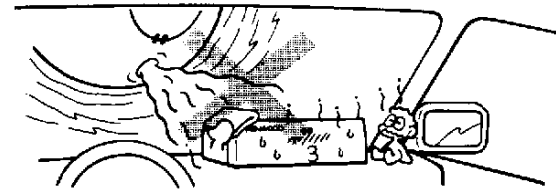

To ensure good ventilation, do not put anything on top of the cabinet and allow at least 15 cm (6 inches) of space behind the unit.

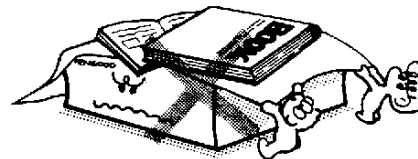

The power requirement is 13.8 VDC.

Never attempt connection to a 24 VDC source.

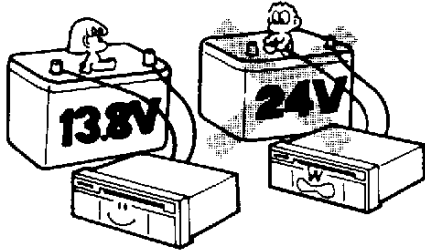

Do not place the unit in areas of excessive dust, high humidity or on unstable surfaces.



Do not drop pieces of metal, needles, coins and other electrically conductive materials into the unit.

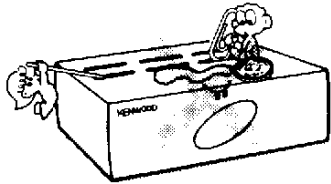

Do not touch the power plug, when your hands are wet.

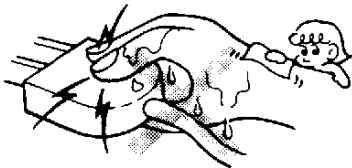

Do not pull the power cord, when disconnecting it from the AC wall outlet. Grasp the plug and ensure that your fingers do not touch the live pins.



If an abnormal odor or smoke is detected, immediately turn the power off and pull out the power plug. Contact the KENWOOD service station or your dealer.

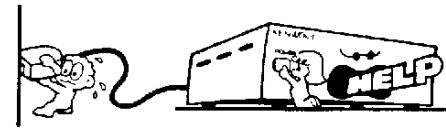

CLEANING

1. Turn the power off, before cleaning the unit.
2. Do not use any type of abrasive pad, thinner, benzine or any substances which may damage the unit.
3. Wipe the front panel and other exterior surfaces of the unit with a soft dry cloth or a soft cloth lightly moistened with water.

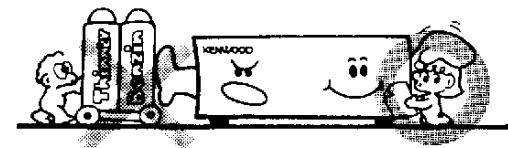

2. SPECIFICATIONS AND ACCESSORIES

2-1. SPECIFICATIONS

Specifications		Models	TM-231A	TM-231E	TM-331A	TM-431A (U.S.A. version)	TM-431A/431E	TM-531A	TM-531E	
General	Frequency range	[MHz]	144 to 148	144 to 146	220 to 225	438 to 450	430 to 440	1240 to 1300		
	Mode		F3E (FM)							
	Antenna impedance		50Ω							
	Power requirements		13.8 VDC ± 15% (11.7 to 15.8)							
	Ground		Negative							
	Frequency stability		Less than ± 10 ppm					Less than ± 3 ppm		
	Current drain	Transmit mode		Less than 11 A		Less than 6.5 A	Less than 9.5 A		Less than 5.5 A	
		Receiver mode with no signal		Less than 0.6 A						
	Operating temperature		- 20 °C to + 60 °C (- 4 °F to + 140 °F)							
	Dimensions (W×H×D) (Projection included)	[mm]	140×40×160 (5-1/2" × 1-37/64" × 6-19/64") (141×42×171 (5-9/16" × 1-21/32" × 6-47/64"))							
Weight	[kg]	1.2 (2.65 lbs)								
Transmitter	Output power*	HI	50 W		25 W	35 W		10 W		
		MID	10 W		10 W	10 W		-		
		LOW	Approx. 5 W		Approx. 5 W	Approx. 5 W		1 W		
	Modulation		Reactance modulation							
	Spurious radiation		Less than - 60 dB					Less than - 50 dB		
	Maximum frequency deviation		± 5 kHz							
Audio distortion (at 60% modulation)		Less than 3% (300 to 3000 Hz)								
Microphone impedance		500 to 600 Ω								
Receiver	Circuitry		Double conversion superheterodyne							
	Intermediate frequency	1st/2nd	10.7 MHz/455 kHz		30.825 MHz/455 kHz		59.7 MHz/455 kHz			
	Sensitivity (12 dB SINAD)		Less than 0.16 μV							
	Selectivity	- 6 dB		More than 12 kHz						
		- 60 dB		Less than 24 kHz					Less than 36 kHz	
	Squelch sensitivity		Less than 0.1 μV							
	Output (5% distortion)		More than 2 W across 8 Ω loads							
External speaker impedance		8 Ω								

Notes:

1. Circuit and ratings are subject to change without notice due to advancements in technology.
2. * Recommended duty cycle: 1 minute Transmit, 3 minutes Reception.

2-2. ACCESSORIES

Unpack your new transceiver carefully and examine it for visible damage. If the equipment has been damaged in shipment, notify the transportation company immediately. Save the boxes and packing material for future shipping.

The following accessories should have been included in the box with the transceiver.

MC-44DM DTMF Microphone (U.S.A. only)	T91-0380-X5.....	1 ea.
or Dynamic Microphone	T91-0379-X5.....	1 ea.
or Dynamic Microphone (European version) ..	T91-0382-X5.....	1 ea.
Microphone Hook (U.S.A. only)	J20-0319-24	1 ea.
Self Tapping Screw (U.S.A. only)	N46-3010-46.....	2 ea.
Mobile Mounting Kit (1 ea.)		
Bracket	J29-0436-03	1 ea.
Mounting screws.....	N99-0331-05.....	1 ea.
SEMS Screw	4 ea.	
Self Tapping Screw	4 ea.	
Flat Washer	4 ea.	
Wrench	W01-0414-04.....	1 ea.
Stacking Plate (TM-331A/431A/431E/531A/531E) ..	J21-4147-14	2 ea.
DC Power Cable.....	E30-2111-05	1 ea.
Fuse.....	1 ea.	
TM-231A/231E: 15 A.....	F05-1531-05	
TM-431A/431E: 10 A.....	F05-1031-05	
TM-331A/TM-531A/531E: 8 A	F05-8021-05	
Instruction Manual.....	B50-8286-XX	1 copy
Warranty Card (U.S.A. version, European version)		1 ea.

3. INSTALLATION INSTRUCTIONS

3-1. INSTALLATION

Mounting Bracket

When installing the transceiver in your vehicle consider the ease of operation and safety when selecting the location for the mounting bracket.

1. Install the bracket using the flat washers and self tapping screws that were supplied with the transceiver. (4 Pieces ea.)
2. Attach the transceiver loosely using the 4 SEMS screws that were supplied.
3. Align the grooves in the bracket with the transceivers screws (Fig. A) and slide the transceiver to the rear.
4. Adjust the viewing angle of the bracket to the desired position. (Fig. B)
5. Hold the transceiver in place and tighten the 4 SEMS screws, using the wrench that was supplied.

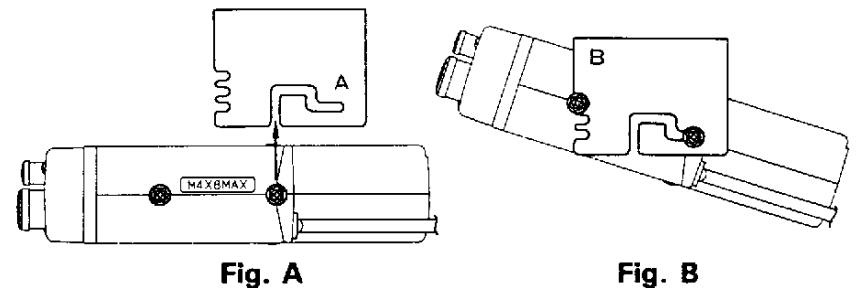

3-2. CONNECTION

3-2-1. Mobile Installations

Cautions:

1. Before installing the power cable disconnect the negative lead from the battery for safety.
2. After installation and wiring have been completed go back and check your work to ensure that you have not made any errors, before you reconnect the negative battery lead.
3. If the fuse opens be sure to check that each conductor is undamaged, then replace the fuse with one of the same rating.
4. After completing the wiring, wrap the fuse holder with heat resistant tape to protect against heat and moisture.
5. Do not remove the fuse even if the power cable is too long.

A. Battery Connections

Connect the power cable directly to the battery terminals. Use of the cigarette lighter socket will lead to a poor connection, and will result in poor performance. Play close attention to the polarity of the cables when connecting them to the battery. Remember Red is positive and black is negative !

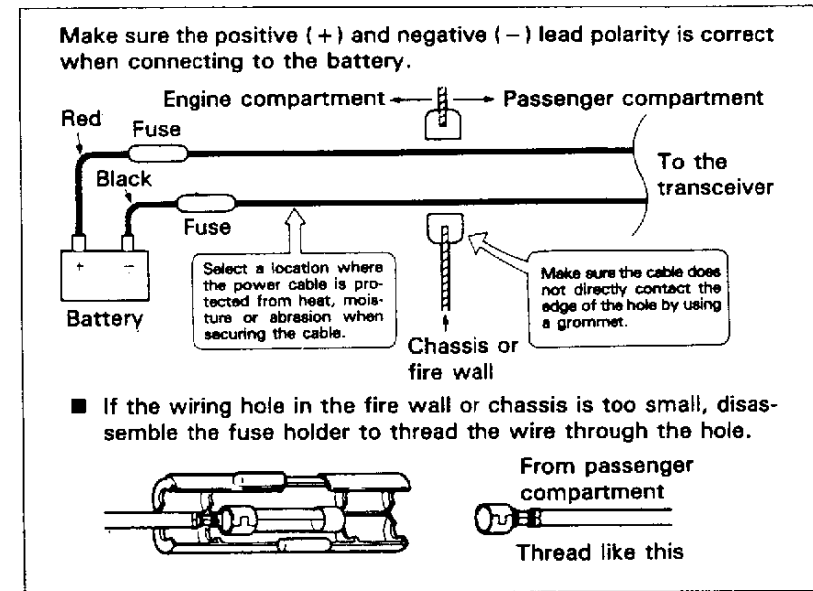

B. Ignition Noise

This transceiver has been designed to suppress ignition noise, however, you may occasionally encounter an installation where the use of suppressor type plugs might be called for.

3-2-2. Fixed Station

A regulated DC power Supply (13.8 VDC) is required. The PS-430 or the PS-50 are recommended.

CAUTION:

1. Never connect the AC power cable of the Power supply to the AC outlet until all other connections have been made.

2. Before connecting and disconnecting the power connector be sure to turn OFF the POWER switch on the front panel of the transceiver and the power supply.
 3. Observe proper polarities when connecting the DC power cable to the supply.
Remember red is positive and black is negative.
-

3-2-3. Antenna

The type of antenna that is used will greatly affect the performance of the transceiver. Use a properly adjusted antenna, of good quality, to enable your transceiver to perform at its best. The antenna input impedance is 50 ohms. Use 50 ohm coaxial cable such as RG-8U or 8D-2V for this connection. If the antenna is far from the transceiver the use of low loss cable is recommended. Match the impedance of the coaxial cable and that of the antenna so that the SWR will be less than 1.5 to 1. The protection circuit in the transceiver will activate if the SWR is particularly poor (greater than 3 to 1). High SWR values will cause the transmitter output to fall off and may lead to TVI or BCI reports.

CAUTION: _____

We recommend that you install a high quality lightening ar-restor in your antenna lines for protection against fire, electric shock, personal injury, or damage to the radio itself.

4. OPERATION

4-1. CONTROL FUNCTIONS

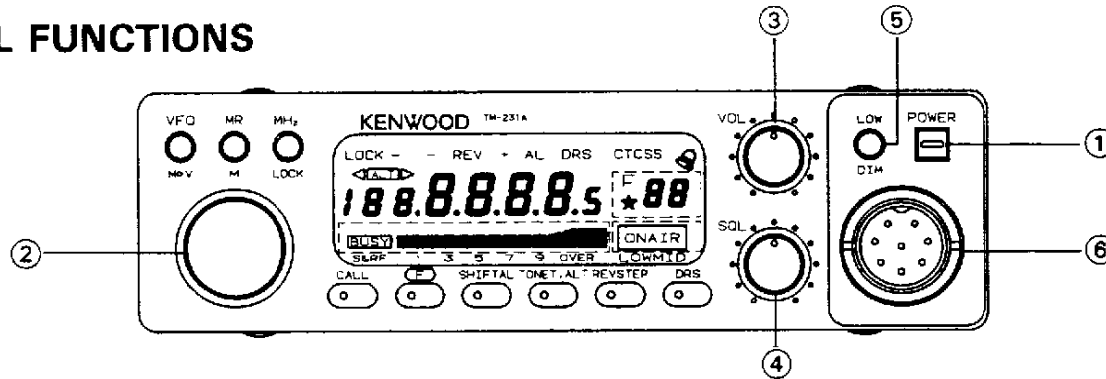

① POWER switch

Press to turn the transceiver ON or OFF.

② Tuning control

This control is used to select the desired transmitter/receiver frequency, MHz step, Memory Channel, Frequency Step, Tone Frequency, Scan Direction, etc.

③ VOL control

This control is used to adjust the volume from the internal and external speaker (if used). Clockwise rotation will increase the volume and counterclockwise rotation will decrease the volume.

④ SQL (Squelch) control

This control is used to select the desired squelch threshold level.

⑤ LOW/DIM key

LOW

This function is used to select the transmit output power level (HI, MID, or LOW). Note the TM-531A/531E does not have a MID position.

DIM

This function is used to select the intensity of the front panel display illumination. It is used in conjunction with the F key, i.e. press the F key and then the LOW/DIM key to alternate between High and Low display intensities.

⑥ Microphone connector

Attach the supplied microphone to this connector. The pin out of the connector is described in the accompanying illustration.

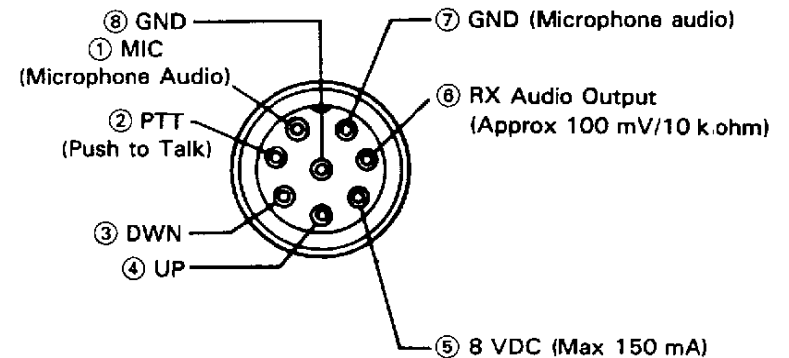

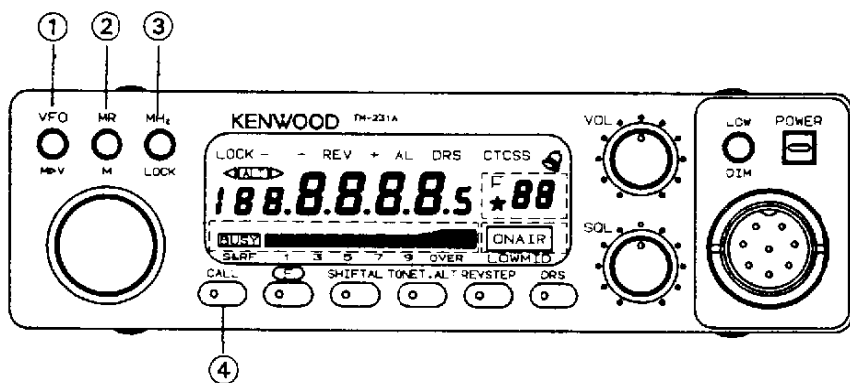

① **VFO key**

This key is used to return to VFO operation after operating in the MR or CALL channel mode. Pressing this switch will allow the tuning control and microphone UP/DWN keys to increase or decrease the operating frequency.

Press and hold the key for longer than 1 second to initiate VFO scan. Pressing the key after scan has been initiated will cause scan to stop.

Pressing the key within 10 seconds of pressing the F key will copy the memory channel or call channel data to the VFO. This allows you to change parameters of that channel without actually changing the data that has been stored in memory.

Pressing the F key for longer than 1 second and then pressing the VFO key will cause radio to toggle the hold/resume mode between Time Operated scan and Carrier Operated scan.

If you press and hold the VFO key while you turn on the POWER switch you will reset the microprocessor's VFO memory, without destroying the memory channel or call channel data.

② **MR key**

This key is used to select MR (Memory Recall) mode from the VFO mode. The tuning control can then be used to select the desired Memory channel.

Pressing the key for longer than 1 second will initiate memory channel scanning.

Pressing the key within 10 seconds of pressing the F key will store the displayed data into memory.

In the MR channel mode pressing the F key for longer than 1 second and then pressing the MR key will cause the Memory channel to skip during Memory channel scan mode.

If you hold and press this key while you turn on the POWER switch you will clear all the microprocessor's, operator programmed, memory section.

③ **MHz key**

This key is used to tell the microprocessor that you wish to increase or decrease the operating frequency in 1 MHz increments.

Pressing this key within 10 seconds of pressing the F key will cause the key lock function to activate, protecting the currently displayed data from accidental erasure.

④ Call key

Press this key to activate the call channel function.

Press the F key momentarily and then press the CALL key to store the currently displayed data into the CALL channel. The radio will allow you up to 10 seconds to press the CALL key after pressing the F key.

Press the F key for longer than one second so that the F indicator begins to flash. Then press the CALL key to enter the lower limit for the programmable VFO tuning limit function. If you wait longer than 10 seconds to press the CALL key after the F begins flashing the microprocessor will assume that you pressed the key in error and cancel the function. You will have to start over again if the F indicator turns off.

To operate the transceiver with the RC-10 press and hold the CALL key on the transceiver and then turn on the POWER switch.

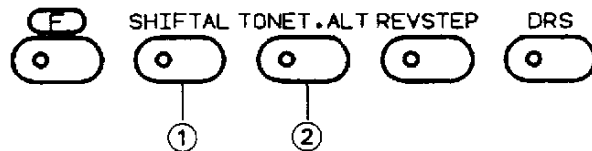

① SHIFT/AL key

SHIFT function

Pressing this key alone to select the desired transmitter offset direction. Pressing the key will cause the radio to shift from one offset direction to the other, i.e. " + " to " - " to simplex where no indicator shows. (" - " to " - - " for TM-431E European versions)

AL function

Pressing the F key momentarily and then pressing the SHIFT/AL key will cause the radio to activate the Priority Alert function. When this function is active the radio will scan the contents of memory channel 1 at approximately 5 second intervals. If there is activity on the frequency a beep will sound from the speaker. Pressing the same key sequence again will cancel the function.

Pressing the F key for longer than 1 second and then pressing the SHIFT/AL key will store the currently displayed data as the upper limit for the programmable VFO tuning limit function.

② TONE/T.ALT key

Pressing this key by itself causes the radio to select the desired tone signalling mode. When the "T" indicator is illuminated in the display the transceiver will transmit the selected subaudible tone. When the "CTCSS" indicator is illuminated the transceiver will both transmit the subaudible tone and will also remain squelched until the proper subaudible tone is received.

If you press the F key momentarily and then press the TONE/T.ALT key the T.ALT function will be activated. This function will cause the radio to emit a series of beeps when an incoming signal is received that will open the squelch. The function will work with or without the CTCSS option installed.

TONE frequency selection

Pressing the F key for longer than one second and then pressing the TONE/T.ALT key will allow you to select the desired tone frequency. The display will indicate the current Tone frequency. To change to a different tone frequency rotate the tuning control or press the UP/DWN switches on the microphone until the desired tone frequency appears in the display. To return to the normal frequency display you can press any front panel key except the power switch.

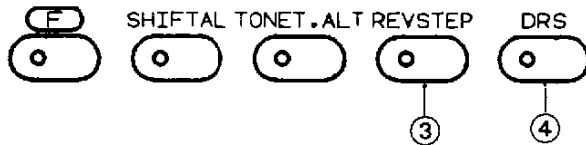

③ REV/STEP key

This key is used to reverse the transmit/receive frequencies during repeater operations. If you have selected simplex this key will not function !

Pressing the F key momentarily and then the REV/STEP key will allow you to select the desired VFO tuning step and Scan step size. Use the tuning control to select the desired tuning step and then press any front panel key except the POWER switch to return to the normal frequency display.

Pressing the F key for longer than 1 second and then pressing the REV/STEP key will turn the BEEP function Off or ON.

④ DRS/ALT (ALT: TM-531A/531E only)

This key is used to turn the Digital Recording System off or on. Please see page 31 for additional information on this optional accessory.

Pressing the F key momentarily and then the DRS/ALT key will cause the ALT function of the TM-531A/531E to activate.

LCD DISPLAY PANEL

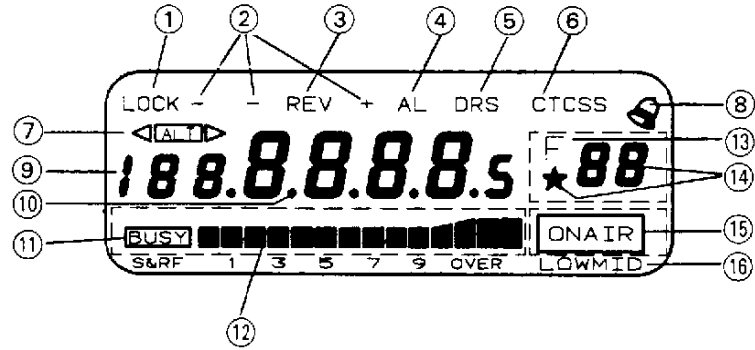

- ① LOCK On when the LOCK function has been activated.

- ② - + Displays the selected transmitter offset direction.
 - - (European version)
- ③ REV On when the Reverse function has been activated.

- ④ AL On when the Priority Alert function has been activated.

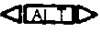

- ⑤ DRS On when the Digital Recording System is active.

- ⑥ CTCSS On when the Tone Decode function is active.
 ↑
 On when the Tone Encode function is active.

- ⑦  On when the Auto Lock Tuning function is active. When the ALT system is operating direction the direction indicator will turn on if the system shifts the receiver frequency.

- ⑧  On when the Tone Alert function is active. The indicator flashes when an incoming signal has opened the squelch.

- ⑨  Displays the operating frequency to the nearest kHz digit; the frequency step size; or the tone frequency.

- ⑩  The indicator flashes when scanning.
- ⑪  On when the squelch opens.

- ⑫  This level meter indicates the relative receiver signal strength or the relative transmitter power output.

- ⑬  On whenever the F key has been depressed. Also shows the last memory channel number that had been selected.

- ⑭  The ★ indicator is on whenever the displayed memory channel will be skipped during memory scan operations.

- ⑮  On during transmit.

- ⑯ LOWMID Indicates the relative output power setting for transmit. No indicator indicates full power.

Rear Panel

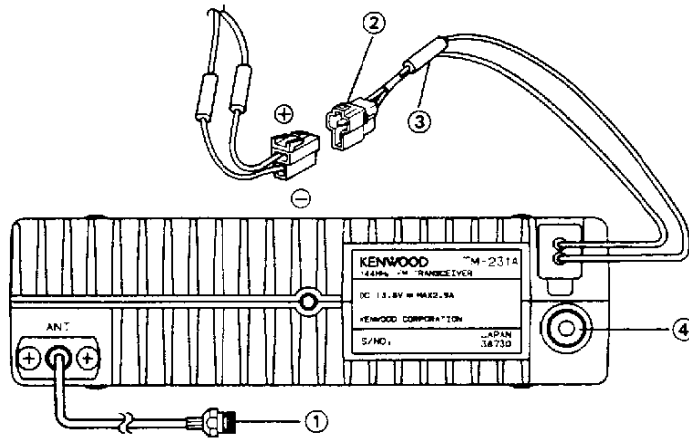

- ① **ANTENNA connector**
Attach an antenna with a low SWR and impedance of 50 ohms.
- ② **13.8 VDC power input connector**
Connect the supplied DC power cable to this connector. Pay close attention to the polarity. Red is positive and black is negative.
- ③ **Fuse holder**
Contains one of the following fuse. Do not use a larger fuse as damage might result to the transceiver.
 TM-231A/231E : 15 A
 TM-431A/431E : 10 A
 TM-331A/TM-531A/531E : 8 A
- ④ **External speaker jack**
This jack is used to connect an external speaker. The speaker should have an impedance of 8 ohms.

Microphone

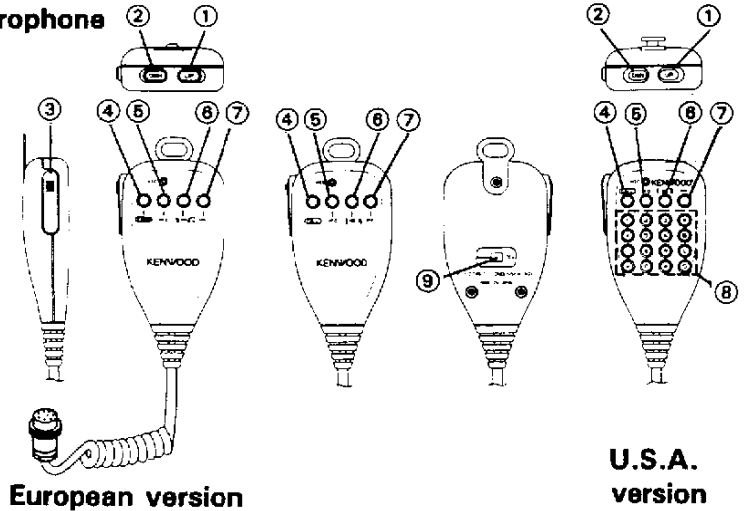

- ① ② **UP/DWN switches**
These switches can be used to increase or decrease the VFO frequency, the Memory channel number, and the Tone frequency, etc..
- ③ **PTT (Push to Talk) switch**
The transceiver will transmit whenever this switch is depressed. Scan operations may be cancelled by pressing this switch without transmitting.
- ④ **CALL key (except European version)**
This key functions just like the CALL key on the front of the radio.
1750 key (European version)
The transceiver will transmit with 1750 Hz repeater access tone whenever this switch is depressed.
- ⑤ **VFO key**
This key functions just like the VFO key on the front of the radio.

⑥ **MR key**

This key function just like the MR key on the front of the radio.

⑦ **PF (Programmable Function) key**

This key can be programmed to perform any of the following functions:

MHz key (Initial setting from the factory); or SHIFT key; or TONE key; or REV key; or DRS key; or LOW key.

To program the key use the following procedure:

1. Turn the POWER switch on the transceiver OFF.
2. Press and hold the key on the front panel of the set that corresponds with the function you wish to program the microphone key to perform.
3. Turn on the POWER switch while the key on the front panel is held in.
4. Release the front panel key.

One additional function can be programmed that is not included on the front panel of the transceiver. This is known as the MONITOR function. This will allow you to open squelch to check the band for a clear frequency. This will function even if you are operating in the CTCSS decode mode. MONITOR programming: Press and hold the F key on the front panel as you turn on the POWER switch of the transceiver and then release the F key.

⑧ **16-Tone DTMF keypad (U.S.A. version only)**

These buttons are used to activate the DTMF encoder. See 4-6-4. for further information on their use.

⑨ **LOCK switch**

This key will deactivate all functions of the microphone except the PTT function and DTMF key pad.

4-2. RECEIVER OPERATIONS

Audio confirmation is provided whenever a front panel key is depressed. You can disable this function by pressing the F key for longer than 1 second and then pressing the REV/STEP key.

4-2-1. RECEPTION

1. Connect the power supply, antenna, and microphone and then adjust the controls as follows:
Power Switch OFF
Vol Control Full Counterclockwise
Power switch of power supply OFF
(Fixed station)
SQL Control Full Counterclockwise

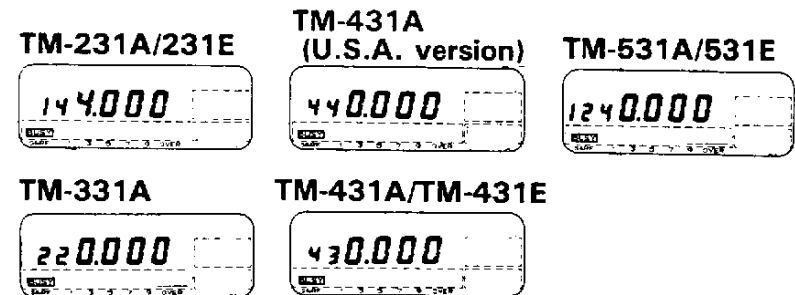

Fig. 1

2. Turn on the Power Supply and then turn on the transceivers POWER switch. The display should indicate a frequency. Fig. 1 shows examples of frequencies that will appear on the various models. In addition to the frequency you may see one or more control indicator turn on in the display.

Note:

The frequencies shown above are the default frequencies after a microprocessor reset. If the display shows incomplete data or you think the displayed frequency is in error you should reset the microprocessor using the instructions provided in the Microprocessor Memory Initialization on page 21.

3. Rotate the VOL control clockwise until a signal or noise is heard coming from the speaker.
4. Rotate the tuning control or press the microphone UP/DWN switches to select an open channel. Then rotate the SQL control clockwise until the noise just disappears and the BUSY indicator turns off. This point is known as the Squelch Threshold point. The squelch control must be adjusted to this setting for the Scan functions to operate properly.
5. Select the desired operating frequency using the microphone or tuning control. When a signal is received the S-meter will deflect and the BUSY indicator will turn On.

CAUTION:

Turn off the transceivers POWER switch before you start or stop you vehicles engine, or home power supply.

4-2-2. Frequency Selection

You can change the dial frequency while in the VFO mode. The frequency can then be also be stored in memory, or in the call channel using the techniques that will be described in this manual.

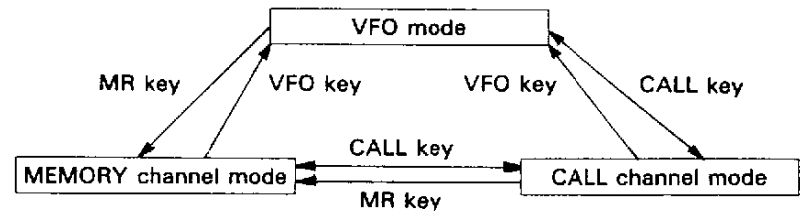

● **VFO Mode Operation Frequency Selection**

1. Press the VFO key to select the VFO mode.
2. Rotate the tuning control or press the microphone UP/DWN switches to select the desired frequency.

● **Memory Channel Selection**

1. Press the MR key.
2. Rotate the tuning control or press the microphone UP/DWN switches to select the desired memory channel.

● **CALL Channel Selection**

Press the CALL key to select the Call channel.

4-2-3. Frequency Step Selection

The frequency step is indicated in the chart below.

	5 ↔	10 ↔	15 ↔	20 ↔	12.5 ↔	25
TM-231A/231E	○	○	○	○	○	○
TM-331A	○	○	○	○	○	○
TM-431A/431E	○	○	○	○	○	○
TM-531A/531E	NA	○	NA	○	○	○

To select the desired tuning or scan step size use the following procedure:

1. Press the VFO key to select the VFO mode.
2. Press the F key momentarily. The F indicator should light in the display.
3. Press the REV/STEP key within 10 seconds of pressing the F key. The current frequency step size will be displayed.
4. Rotate the tuning control or press the UP/DWN switches on the microphone until the desired tuning step size appears in the display.
5. To complete the programming of the step size you can press any key on the front panel except the POWER key, or simply wait 10 seconds and the microprocessor will automatically return to the normal frequency display.

The chart below shows how the microprocessor will correct a new step size.

5, 10, 15, 20 to 12.5, 25		
0, 5	10, 15	0
20, 25	30, 35	25
40, 45	50, 55	50
60, 65	70, 75	75
80, 85	90, 95	

12, 5, 25 to 5, 10, 15, 20		
0	12.5	0
25	37.5	10
50	62.5	20
75	87.5	30
0	12.5	50
25	37.5	60
50	62.5	70
75	87.5	80

4-2-4. Programmable VFO tuning limits

The TM-231 series radios provide the capability of programming the VFO tuning range, in 1 MHz band segments, as well as providing a separate programmable band scan function (See section 4-5). For example you could tell the transceiver that you only wish to tune the 144.000 MHz and 145.000 MHz band segment by specifying any frequency within these two segments. The tuning controls, microphone UP/DWN switches would then only tune within these specific bands. The procedure for specifying the bands is described below.

1. Press the VFO key to select the VFO mode.
2. Rotate the tuning control or press the microphone UP/DWN switches until the desired lower tuning range appears in the frequency display.

For example with the TM-431 you might want to select the 432.000 MHz band, and dial up 432.560 MHz.

3. Press the F key for longer than 1 second. The F indicator should begin flashing.

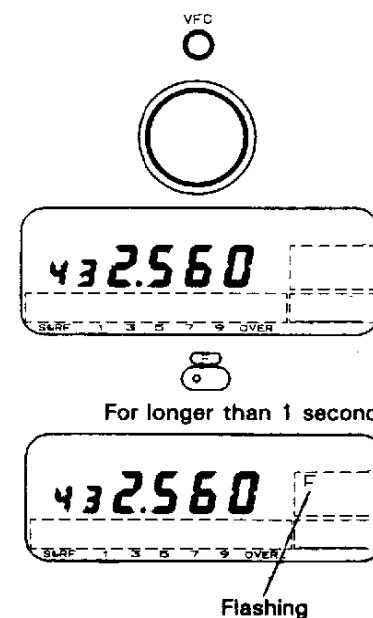

4. Press the CALL key within 10 seconds. A long beep will sound and the F indicator will turn off in the display. This indicates that the lower limit has been successfully stored in memory.



5. Now select the desired upper tuning limit using the MHz key and tuning control, or microphone UP/DWN switches. With our example TM-431 we want the upper band limit to be in the 435 MHz band, and therefore dial up 435.560 MHz.



6. Press the F key for longer than 1 second. The F indicator will again begin flashing.



For longer than 1 second

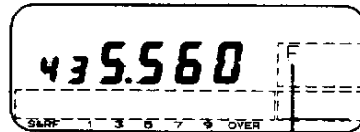

Flashing

7. Press the SHIFT/AL key within 10 seconds. A long beep will sound and the F indicator will turn off in the display. This indicates that the upper limit has been successfully stored in memory.



8. To confirm that the programming was properly performed rotate the tuning control or press the UP/DWN switches. The transceiver should not go above or below the programmed band limits.

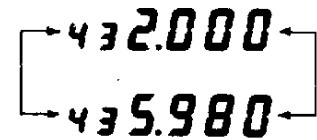

9. To clear both programmed limits simultaneously you should initialize the VFO memory using the procedures discussed on page 10. You can reprogram either limit independently by following the appropriate instructions above.



Note: _____
 An internal heterodyne tone resulting from internal mixing may be encountered near by 1244.150 MHz.
 (TM-531A/531E only)

4-2-5. ALT (TM-531A/531E only)

The ALT system operates similar to an AFC (Automatic Frequency Control) system. This system is useful when the frequency of either station starts to drift. When this occurs distortion of the signal is the usual result. The ALT system will detect the drift and shift the frequency to compensate.

(Example)

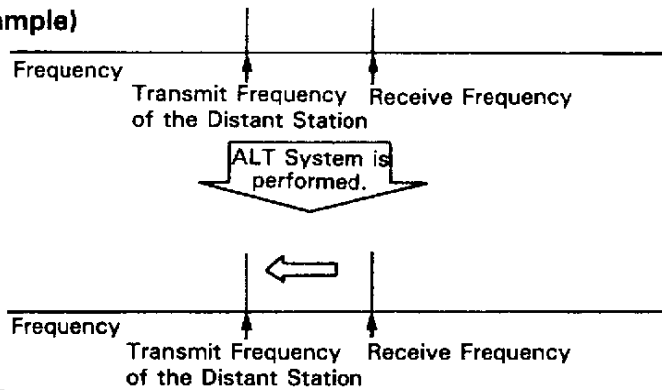

Note:

The frequency display will not actually change, even though the receive frequency might shift in order to properly tune the incoming signal. When the ALT system is operating the Direction indicator in the display will turn on to signal a change in the receiver frequency. The direction indicator will show you if the incoming signal was higher or lower than the displayed frequency.

To activate the ALT function

1. Press the F key momentarily. The F indicator will turn on in the display.
2. While the F indicator is on press the DRS/ALT key. The ALT indicator will turn on and the receiver will automatically center itself on the incoming signal.
3. To release the ALT function press the F key momentarily and then the DRS/ALT key.

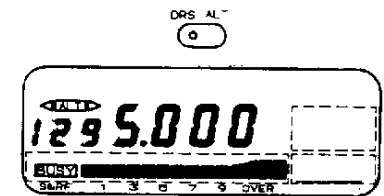
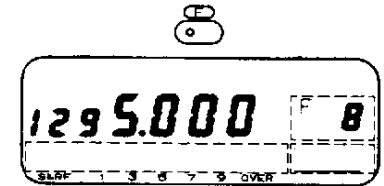

Turns on when the transmit frequency of the distant station is higher than your receive frequency.



Turns on when the transmit frequency of the distant station is lower than your receive frequency.

4-3. TRANSMITTER OPERATION

Cautions:

1. Ensure that an antenna with a low standing wave ratio (SWR) is attached to the antenna connector before attempting to transmit. Failure to provide proper termination may result in damage to the final amplifier section.
2. Always check to ensure the frequency is clear before transmitting.

Note:

The use of LOW power is recommended, whenever possible, to avoid interfering with other stations.

Transmit

1. Select the desired operating frequency using any of the methods previously discussed.
2. Check the frequency to see if it is occupied before you transmit.
3. Press the PTT switch. The ON AIR indicator will light, and the RF meter will deflect to the right.

Note:

If you have selected the LOW power position, the low indicator will appear in the display and the RF meter will only deflect slightly. When HI power has been selected the RF meter will swing full scale.

4. Speak into the microphone. The recommended distance to the microphone is 5 cm (2 inches).

Note:

Talking closer may result in overdeviation of your transmit signal, which might be reported as a loss of clarity or of an excessively wide transmit signal. Talking too far away may result in reports of weak audio.

5. Release the PTT switch to return to the receive mode. The ON AIR indicator should go out, and the RF meter will return to zero.

4-4. MEMORY OPERATIONS

4-4-1. Microprocessor Memory back-up

A lithium battery is contained in this transceiver to retain memory. Turning OFF the POWER switch, disconnecting the power cable or an intermittent power failure will not erase the memories. The battery life is estimated at 5 years. When the battery has been exhausted erroneous information might appear in the display.

Lithium battery replacement should be performed by an authorized KENWOOD service facility, or your authorized KENWOOD dealer. This equipment contains CMOS circuitry and can be damaged by improper replacement procedures.

4-4-2. Microprocessor Initialization

The initial state of the microprocessor, as delivered from the factory is shown in the following chart.

	TM-231A	TM-231E	TM-331A	TM-431A	TM-431E	TM-531A	TM-531E
VFO Frequency	144.000 MHz		220.000 MHz	440.000 MHz (U.S.A. version) 430.000 MHz	430.000 MHz	1240.000 MHz	
Frequency Step	5 kHz	12.5 kHz	20 kHz	25 kHz			
Memory Channel	Memory channel 1						
Memory Channel	144.000 MHz		220.000 MHz	440.000 MHz (U.S.A. version) 430.000 MHz	430.000 MHz	1240.000 MHz	
Tone Frequency	88.5 Hz						

Microprocessor Initialization

When you want to erase all programmed data, or if the display should show erroneous information you should initialize (reset) the microprocessor using the following procedure.

1. Turn the POWER switch OFF.
2. Press and hold the MR key.
3. Turn on the POWER switch.
4. Release the MR key.

4-4-3. Special Memory Channels

This transceiver provides 20 Memory Channels. In addition to serving as normal memory channels some of the channels serve a dual purpose and specify other parameters. The functions of these memory channels is described below.

- * Memory Channel 1 is used to store the frequency of the Priority Alert function.
- * Memory Channel 15 is used to store the lower limit for the Programmable band scan function.
- * Memory Channel 16 is used to store the upper limit for the Programmable band scan function.
- * Memory Channels 17-20 are used to store odd split repeater data.

4-4-4. Memory Contents

Each Memory channel is capable of storing the following information.

	1-16	17-20	CALL
Frequency data	○	○	○
Tone Frequency	○	○	○
Tone status	○	○	○
CTCSS status and Tone Frequency	○	○	○
Frequency step	○	○	○
Shift status	○	X	○
Reverse status	○	X	○

4-4-5. Memory Entry

■ Simple/Normal transmitter offsets

1. Press the VFO key to select the VFO mode.
2. Select the desired operating frequency, offset direction, tone frequency, CTCSS status etc. (For example 146.790 MHz)

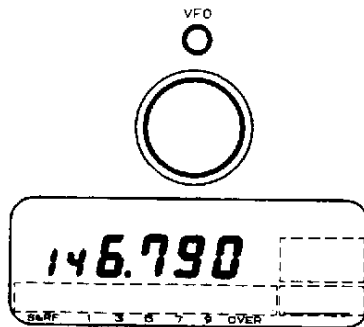

3. Press the F key momentarily. The F indicator will turn on in the display, and a memory channel number will appear. (Channel 8 for example)

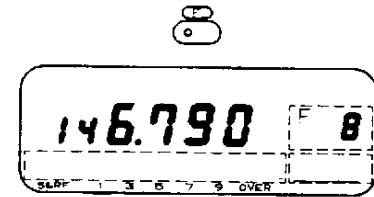

4. Select the desired memory channel number by rotating the tuning control or by pressing the UP/DWN switches on the microphone. (Channel 5 for example)

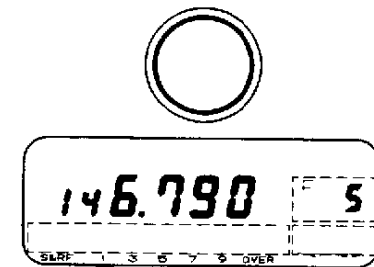

5. Press the MR key within 10 seconds of selecting the memory channel number. A long beep will sound and the F indicator and memory channel number will turn off. This signals that the data has been properly stored in memory.

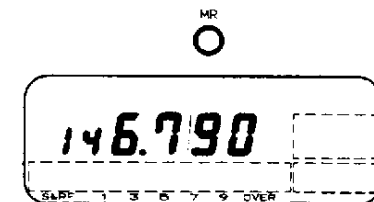

■ Odd Split Memory Channels

1. Press the VFO key to select the VFO mode.
2. Select the desired receiver frequency, tone information etc. (For example 145.600 MHz)

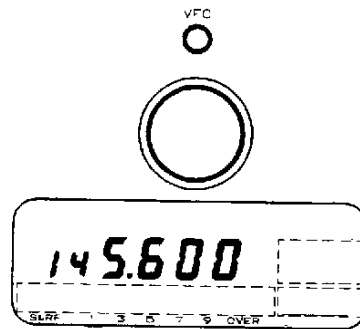

3. Press the F key momentarily. The F indicator and a memory channel number will appear in the display. (Channel 5 for example)

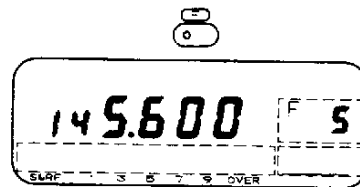

4. Select any memory channel from 17 thru 20 using the tuning controls.

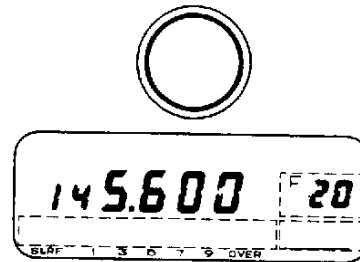

5. Press the MR key within 10 seconds of selecting the memory channel number. A beep will sound and the F and Memory channel indicators will turn off in the display.



6. Within 10 seconds of pressing the MR you should select the desired transmit frequency using the tuning controls or microphone UP/DWN switches. (For example 145.700 MHz)

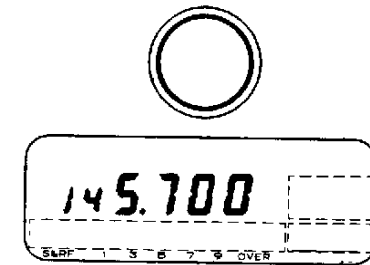

7. Press the MR key within 10 seconds of selecting the transmit frequency. A beep will sound to signal the data has been successfully stored.



8. To confirm the contents of the memory channel press the MR key. The programmed receiver frequency should appear in the display along with both a "-" and "+" offset direction indicator. This signals you that this channel has an odd split entered.

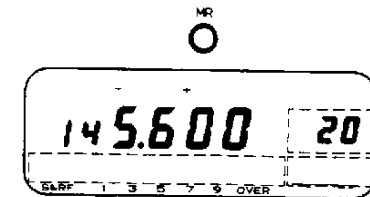

9. To check the transmit frequency press the REV/STEP key or the PTT key. The transmit frequency will appear in the display.

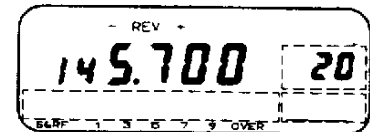

■ Call Channel

1. Press the VFO key to select the VFO mode.
2. Select the desired operating frequency, tone data etc. (For example 449.920 MHz)
3. Press the F key momentarily. The F indicator will turn on and the Memory channel indicator will turn on. (Channel 8 in the example)
4. Press the CALL key within 10 seconds of pressing the F key to enter the data into memory. A long beep will sound and the F indicator and memory channel indicators will turn off to confirm data entry.

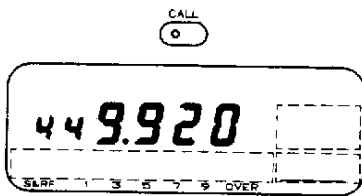
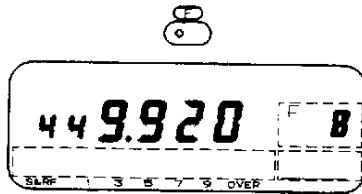
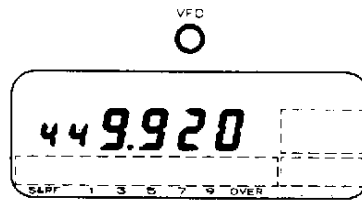

4-4-6. Memory Channel Recall

When recalling a memory channel using this procedure you will not be able to adjust the frequency or tone data. The memory channel acts very much like the old crystal controlled radios, i.e. the data is fixed and cannot be changed by mistake.

1. Press the MR key to select the MR mode. The memory channel indicator will turn on in the display.
2. Rotate the tuning control or press the microphone UP/DWN switches to select the desired memory channel.

4-4-7. Memory Shift

Using this function you can copy the contents of a memory channel or CALL channel to the VFO without changing the data in memory. This will allow you to change the tone data, or tune normally if you wish.

1. Press the MR key or CALL key to select the appropriate mode.

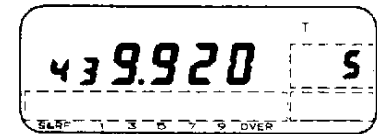

2. Press the F key momentarily. The F indicator will light.

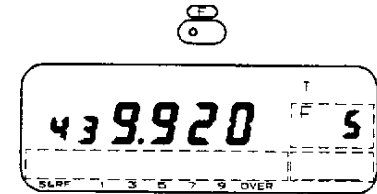

3. Press the VFO key within 10 seconds of pressing the F key. The F indicators will turn off to signal the data has been successfully transferred to the VFO.

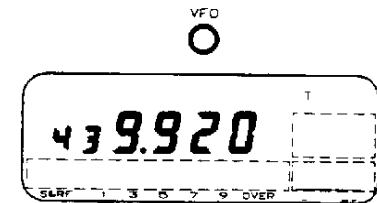

Note:

If an Odd Split Memory channel is selected you will only transfer the Receive data. Transmit data will not be copied.

4-5. SCAN Operations

4-5-1. General

The following scan options are available:

Band Scan

Scan proceeds over the entire band. This function operates in the VFO mode only.

Programmable Band Scan

The scan range in this mode is specified in memory channels 15 and 16. This function operates in the VFO mode only.

Memory Channel Scan

Scan proceed thru those memory channels that have data stored and have not been locked out. This function operates the MR mode only.

Scan can not use in conjunction with the Tone Alert System.

4-5-2. Hold/Resume Programming

Two type of scan hold/resume have been provided in this transceiver.

Time Operated Scan

You may prefer that the radio stops on a busy channel and remains there approximately 5 seconds, and then continues to scan even if the signal is still present.

Carrier Operated Scan

In this mode the radio will stop scanning on a busy channel and remain there until the signal drops out. The radio allows a 2 second delay before it resumes scanning so that you don't loose the station when operators change.

The radio is delivered from the factory in the Time Operated Scan mode. To switch between the two modes use the

following procedure.

1. Press the F key for longer than 1 second. The F indicator will flash.
2. While the indicator is flashing press the VFO key. This will toggle the Hold/Resume mode to the Carrier Operated mode.
3. To return to Time Operated mode repeat steps 1 and 2.

4-5-3. Band Scan

To initiate Band Scan

1. Press the VFO key to select the VFO mode.
2. Adjust the Squelch control to the Threshold point.
3. Press and hold the VFO key for longer than 1 second. The MHz indicator will begin flashing to signal the radio is scanning.

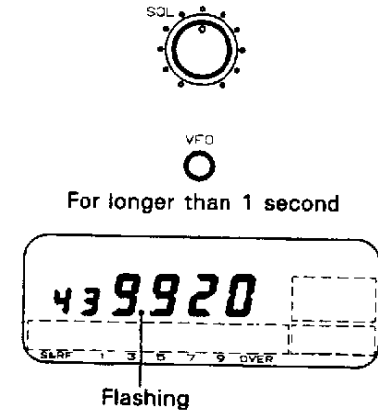

4. Scan will begin in an upwards direction. You can reverse the direction of scan by turning the tuning control counterclockwise or by pressing the DWN switch on the microphone. Clockwise rotation of the tuning control or pressing the UP switch will cause the radio to begin scanning upwards again. The tuning step size depends upon the current STEP selection.
5. Scan will stop on a busy channel, i.e. a station that is strong enough to open squelch and turn on the BUSY indicator.
6. You can cancel scan with any front panel key or the microphone PTT switch.

4-5-4. Programmable Band Scan

1. The lower scan limit should be stored into memory channel 15, and the upper scan limit should be stored into channel 16.

CAUTION:

If the frequency in memory channel 15 is equal to or higher than the frequency stored in channel 16 scan will proceed over the entire tuning range of the set, i.e. it will function like the Band Scan previously described.

2. Adjust the SQL control to the squelch threshold point.
3. Press the VFO key to select the VFO mode.
4. Select a frequency between the two programmed scan limits.
5. Press the VFO key for longer than one second. The MHz indicator will begin flashing as a visual reminder the transceiver is scanning.
6. Scan will begin in an upwards direction. You can change the direction of scan by turning the tuning control or by pressing the microphone UP/DWN switches.
7. Scan will stop whenever a signal is received that will open the squelch of the radio.
8. Press the PTT switch or any front panel key to stop scan.

4-5-5. Memory Channel Scan

If you wish to scan the contents of the memory channels use the following procedure:

1. Adjust the SQUELCH control to the threshold point.
2. Press the MR key for longer than 1 second. The MHz indicator will begin flashing and the memory channel indicator will indicate the memory channels that are being scanned.

3. Scan will begin at the current memory channel and proceed upwards thru the memory channels. You can change the direction of scan by turning the tuning control or by pressing the microphone UP/DWN switches. Only those memory channels that have data entered into it will be scanned.
4. Scan will stop whenever a signal is received that is capable of opening squelch.
5. To cancel scan press the PTT key or any other front panel key.

4-5-6. Memory Channel Lockout

This function allows you to specify which memory channels you wish to scan during the memory channel scan function.

1. Press the MR key to select the Memory Channel Mode.
2. Select the Memory Channel that you wish to skip by turning the tuning control or by pressing the microphone UP/DWN switches.
3. Press the F key for longer than 1 second. The F indicator will begin to flash. Within 10 seconds of pressing the F key press the MR key. A ★ will appear to the left of the memory channel number. This indicates the Memory channel will be skipped during the Memory Channel scan mode.

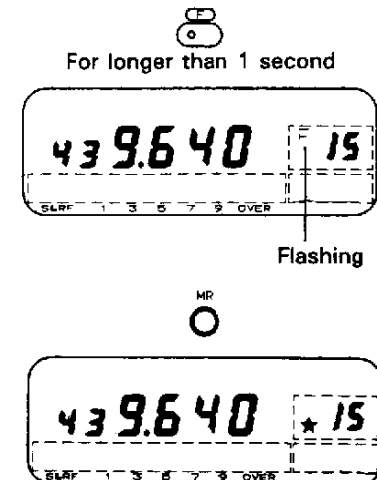

4. Repeat steps 2 and 3 to lock out any other channels you wish to skip.
5. To cancel the lockout, select the desired Memory Channel as described in steps 1, 2 and 3 above. A star should appear to the left of the memory channel number. To cancel the lock out press the F key for longer than 1 second and then press the MR key. The star indicator should turn off.

4-5-7. Priority Alert Function

The priority alert function allows you to monitor memory channel 1 for activity even when you are tuned to a different channel number. When the Priority Alert function has been activated the microprocessor will switch the transceiver to the frequency stored in memory channel 1 once every 5 seconds. The transceiver will determine if a signal is present. If no signal is present the transceiver will return to the original frequency. If a signal is present beep will sound from the speaker to signal the channel is busy. This whole process takes just a fraction of a second, so you will not see the display frequency change. The only thing you will notice is a momentary loss of the signal on the currently displayed frequency. To activate the priority alert function:

1. Ensure the frequency you wish to monitor has been entered into memory channel 1.

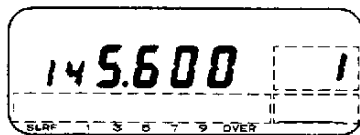

2. Adjust the SQL control to the threshold point.
3. Press the F key momentarily, and then press the SHIFT/AL key. The AL indicator will turn on in the display to remind you that this function has been activated.

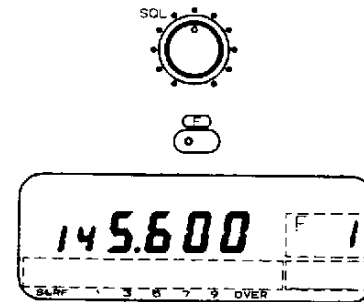

4. If a signal is present a beep will be heard from the speaker.

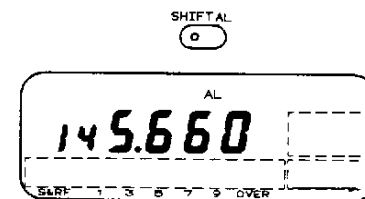

Note: _____
 During the period memory channel 1 is being scanned you will not hear voice communications, only the beep will be heard if a signal is present.

5. To turn this function off repeat step 3. The AL indicator should turn off.

4-6. REPEATER OPERATIONS

4-6-1. Transmitter Offsets

All amateur radio repeaters utilize a separate receive and transmit frequency. The receiver frequency may be either above or below that of the transmit frequency. The configuration of most repeater will fall into one of the categories listed below:

	TM-231A/ 231E	TM-331A	TM-431A	TM-431E	TM-531A	TM-531E
+	+ 600 kHz	+ 1.6 MHz	+ 5 MHz	+ 1.6 MHz	+ 12 MHz	+ 35 MHz
-	- 600 kHz	- 1.6 MHz	- 5 MHz	- 1.6 MHz	- 12 MHz	- 6 MHz
--				- 7.6 MHz		

Offset Direction

To select the desired transmitter offset direction press the SHIFT key. Each time you press the key the transceiver will advance from one direction to the other, i.e. " + " to " - " (" - " to " - - " with European versions) to no offset (simplex).

Automatic Offset Selection (TM-231A/331A U.S.A. version)

The TM-231A/331A has been programmed according to the standard ARRL (Amateur Radio Relay League) Band Plan with regard to transmitter offset direction. Please see the accompanying chart for additional information on this programming. You can, of course, override this by using the SHIFT key if desired.

145.1 145.5 146.0 146.4 146.6 147.0 147.4 147.6 148.0

S	-	S	+	S	-	+	S	-	S
---	---	---	---	---	---	---	---	---	---

S: simplex

	220.000	223.920	224.995
S	S	-	S

4-6-2. Reverse Function

Some repeaters utilize a "Reverse Pair", i.e. the transmit/receive frequencies are exactly the reverse of another repeater. For example repeater A uses 146.000 for a transmit frequency (INPUT) and 146.600 for a receiver frequency (OUTPUT). Repeater B might use 146.600 for a transmit frequency and 146.000 for a receive frequency. It would be inconvenient to have to reprogram the transceiver each time you wanted to use these repeaters.

The REV key allows you to easily reverse the transmit and receive frequencies. To use the REV function press the REV key. The REV indicator will turn on in the display to remind you that you are working a reverse pair.

To return to normal press the REV key again. The REV indicator will turn off.

This function is also useful to check the input frequency of the repeater so that you can determine if you are within range for simplex communications.

4-6-3. Tone and CTCSS operation

Some repeaters require the use of a control signal to activate the repeater. Several different methods are currently in use.

In the United States sub-audible tones are sometimes used. 38 different Sub-audible frequencies are possible. With the use of the optional Sub-Audible tone decoder unit (TSU-6) you will be able to operate in a Tone Operated Squelch

Mode. When this option is installed and the CTCSS function has been activated the radio will not open squelch until the proper PL tone is received.

In Europe a 1750 Hz tone is used in transmit. Press and hold the Microphone 1750 key to transmit with the access tone, you need not press the PTT key.

Since this tone is required in Europe and the United Kingdom a 1750 Hz tone encoder is included with models delivered to these countries.

Tone Frequency Selection

1. Press the F key for longer than 1 second. The F indicator will begin to flash. Press the TONE/T.ALT key within 10 seconds of pressing the F key. The current tone frequency will show in the display.
2. Rotate the tuning control or press the microphone UP/DWN switches to select the desired tone frequency.
3. Press any front panel key to return to the normal frequency display.

Tone Frequency

67.0 Hz	107.2 Hz	167.9 Hz
71.9 Hz	110.9 Hz	173.8 Hz
74.4 Hz	114.8 Hz	179.9 Hz
77.0 Hz	118.8 Hz	186.2 Hz
79.7 Hz	123.0 Hz	192.8 Hz
82.5 Hz	127.3 Hz	203.5 Hz
85.4 Hz	131.8 Hz	210.7 Hz
88.5 Hz	136.5 Hz	218.1 Hz
91.5 Hz	141.3 Hz	225.7 Hz
94.8 Hz	146.2 Hz	233.6 Hz
(97.4 Hz)	151.4 Hz	241.8 Hz
100.0 Hz	156.7 Hz	250.3 Hz
103.5 Hz	162.2 Hz	

Note: 97.4 Hz is available only for encode.

Tone/CTCSS Operation

Press the TONE/T.ALT key and select the desired Tone mode. When the T indicator appears in the display the transmitter will transmit the desired tone. When the CTCSS indicator appears in the display the transceiver will transmit the desired tone and will also operate in the Tone Squelch mode, i.e. squelch will not open until the same tone is received as a portion of the incoming receive signal. When no indicator is on the radio will not make use of either tone feature.

Note:

The tone frequency of 97.4 Hz is available for tone encode only. No Tone Squelch is possible with this frequency.

4-6-4. Autopatch Operations (U.S.A. versions only)

Some repeaters offer a service known as autopatch. This feature allows you to dial a telephone number from your transceiver and carry out a telephone conversation, much like a care telephone, or cellular telephone. This function requires the use of a DTMF (Dual Tone Multi Frequency) pad. The MC-44DM microphone provides the normal keys you would have on your telephone at home, as well as 4 additional keys, the A, B, C, and D keys. These keys are used for control purposes on some repeater systems. You should check with the control operator of the repeater to see if they offer autopatch services. A chart is provided that lists the various tone frequencies that are generated by the Keypad.

To activate the keypad:

1. Press and hold the PTT key.
2. Press the keys just like you would dial you telephone at home.

3. The transceiver will remain keyed for approximately 2 seconds after you press each number, so you can release the PTT switch without unkeying the transceiver.

Note: _____
Some repeaters will require the use of a special key sequence to activate the Autopatch function. You should check with your control operator for this sequence.

Audio tones		(Hz)			
Column	1209	1336	1477	1633	
Row					
697	1	2	3	A	
770	4	5	6	B	
852	7	8	9	C	
941	*	0	#	D	

4-7. Tone Alert System

The Tone Alert function will provide an audible "Alarm" to signal when someone is transmitting on the frequency you are monitoring. When used in conjunction with the CTCSS function this would allow the transceiver to act similar to a private pager system!

1. Adjust the SQL control to the threshold point.
2. If you will be using the CTCSS function you should select the proper tone frequency and ensure the CTCSS indicator is on in the display.
3. Press the F key and then the TONE/T.ALT key. The T.ALT indicator will light.
4. When a signal is received that will open squelch the following actions take place:
The T.ALT indicator will begin to flash.
The busy indicator will turn on.
The audio alarm will sound.



Note: _____
When using the CTCSS function the incoming signal must be present for approximately 2 seconds in order for the T.ALT to function properly.

Tone Alert System can not use in conjunction with Scan.

5. The T.ALT function can be released by pressing the F key and then the TONE/T.ALT key again or by pressing the PTT switch while the T.ALT indicator is flashing.

4-8. Digital Recording System

The optional DRU-1 (Digital Recording Unit) permits you to manually or automatically record up to a maximum of 8 different voice messages for later playback. The automatic recording function works in conjunction with the T.ALT function.

You can select the desired recording mode by pressing the DRS key. Pressing the key will step from DRS mode to Automatic DRS mode to normal mode. The differences in the various modes are explained below.

DRS Mode:	Recording and playback Selectable tone quality level and number of phrases DRS indicator lights in the display
DRS/T.ALT Mode:	Automatic Recording Both the DRS indicator and the T.ALT indicators lit in display
Normal Mode:	No DRS functions active.

The recording conditions are preset at the factory for the following settings:

Tone Quality Level	1
Maximum recording phrase	8
Current Recording Phase number	1 st.

4-8-1. Tone Quality Level Selection

1. Press the DRS key to select the DRS mode. The display will look light the display shown in the figure to the right.

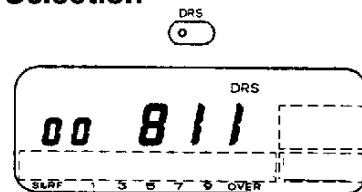

2. Press the REV key. Each time you press the REV key the tone quality indicator will advance, i.e. from 1 to 2 to 3 and then back to 1, etc.

Tone quality 1 will provide the best audio quality, but the shortest recording time. Tone quality settings 2 and 3 provide longer recording times but with an associated decrease in tone quality.

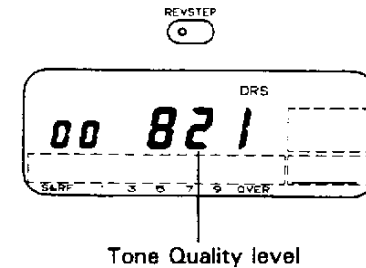

4-8-2. Selecting the maximum number of Phrases

1. Press the DRS key to select the DRS mode. The display panel will be similar to the display at the right.

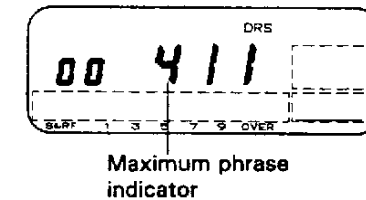

2. Press the SHIFT/AL key. Each time you press the key the maximum phrase indicator will step one position, i.e. from 8 to 4 to 2 to 1 and then back to 8.

The relationship between the maximum number of phrases and the recording time for each phrase is shown in the diagram below:

Maximum number of Phrases	Recording time (Tone Quality settings 1) (second)
8	4 4 4 4 4 4 4 4
4	8 8 8 8
2	16 16
1	32

For example if the current number of phrases is set to "8" each phrase can be a maximum of 4 seconds long at a tone quality level of 1. You will be able to record up to 8 different messages in this setting.

For longer recording you could select a "1" for the maximum number of phrases. This would allow a recording of up to 32 seconds at a tone quality setting of 1.

Extended Recording

The quality of the recording can be reduced in order to increase the available recording time. Two additional settings are available, "2" and "3". The greater the number the longer the recording time but the poorer the quality of the recording. See the accompanying charts for details on these systems.

Maximum number of Phrases	Recording time (Tone Quality settings 2) (second)
8	8 8 8 8 8 8 8 8
4	16 16 16 16
2	32 32
1	64

Maximum number of Phrases	Recording time (Tone Quality settings 3) (second)
8	12 12 12 12 12 12 12 12
4	24 24 24 24
2	48 48
1	96

4-8-3. Recording

Recording an incoming receive signal manually.

1. Select the desired operating frequency. Recordings can be made from the VFO mode, the Memory Mode or the Call Channel mode.
2. Press the DRS key to select the DRS mode. The DRS indicator should turn on in the display. The display should be similar to the one at the right. Select the phrase number by rotating the tuning control.
3. Press the VFO key to begin recording. The recording time indicator will show the elapsed time of the recording.
4. Recording will stop when the time indicator reaches "0". To continue recording from the same frequency rotate the tuning control to the next phrase number and then press the VFO key again to begin recording. Recording will stop when any front panel key is pressed.

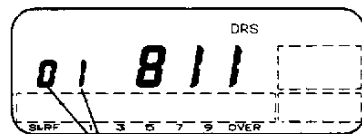
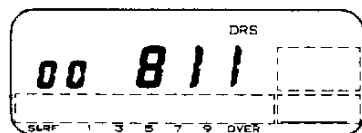
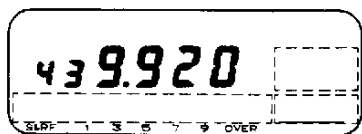

Recording time indicator

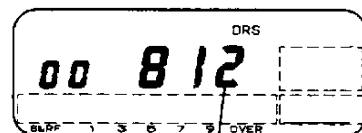

Current phrase number



Recording Signals from the Microphone

1. Press the DRS key to select the DRS mode. The DRS indicator should turn on in the display. Select the desired phrase number by rotating the tuning control or by pressing the microphone UP/DWN switches.
2. Press the MR key to start recording from the microphone. The recording time indicator will indicate the elapsed time of the recording.
If you wish to transmit the same message while recording you should press the microphone PTT switch before you press the MR key.
3. The recording will stop when the elapsed time indicator reaches "0". If you wish to continue recording you will need to rotate the tuning control to the next phrase number and press the MR key again.

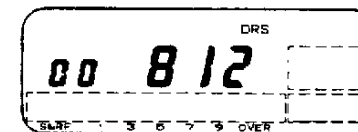

(PTT switch and) 

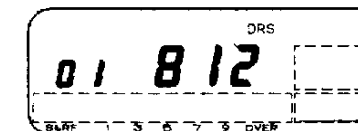

4-8-4. Play Back

1. Press the DRS key to select the DRS mode. The display will indicate something similar to the display at the right. Select the phrase number of the phrase you wish to replay.
2. Press the CALL key to play back the message. If you wish transmit the message at the same time you should press the PTT key before pressing the CALL key. The elapsed time indicator will begin counting the elapsed time.
3. Play back will stop when the time indicator displays "0". You can manually stop the play back by pressing any front panel key.

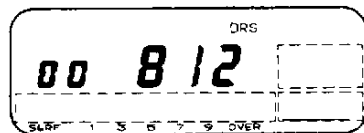

(PTT switch and) 

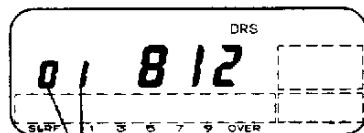

Play back time

4-8-5. Automatic Recording

1. Select the desired operating frequency. Adjust the SQL control to the threshold point. Automatic recording is possible in the VFO mode, Memory Channel mode, or Call Channel mode.

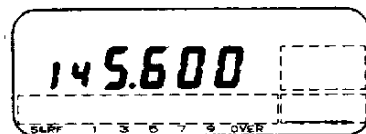

2. Press the DRS key to select the DRS mode.

Select the desired tone quality, the number of recording phrases, and the beginning phrase number.

3. Press the DRS key again to select the Automatic Recording mode. Both the DRS indicator and the T.ALT indicator will turn on.

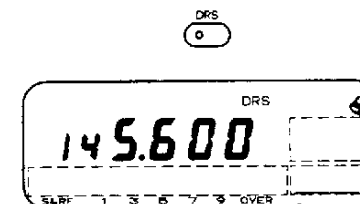
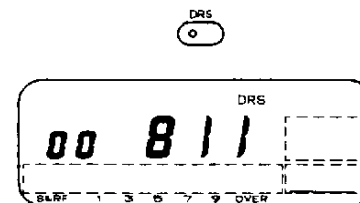

4. Only a signal with the proper CTCSS tone (if the TSU-6 is installed) will initiate recording. If no tone unit is installed the recording will start whenever squelch opens.
5. As with the other DRS recording mode the recording will stop when the elapsed time indicator reaches "0". The transceiver will automatically increment the phrase number in preparation for the next message.

6. MAINTENANCE

6-1. GENERAL INFORMATION

Your transceiver has been factory aligned and tested to specification before shipment. Under normal circumstances the transceiver will operate in accordance with these operating instructions. All adjustable trimmers and coils in your transceiver has been adjusted at the factory and should only be readjusted by a qualified technician with proper test equipment. Attempting service or alignment without factory authorization can void the transceiver's warranty.

When operated properly, the transceiver will provide many years of service without requiring realignment. The information in this section gives some general service procedures which can be accomplished without sophisticated test equipment.

6-2. SERVICE

Should it ever become necessary to return the equipment to your dealer or service center for repair, pack it in its original box and packing, and include a full description of the problems involved. Also include your telephone number. You need not return accessory items unless directly related to the service problem.

Service note: _____

Dear OM, if you desire to correspond on a technical or operational problem, please make your note short, complete, and to the point, and PLEASE make it readable.

Please list: Model and serial number.
The problem you are having.

Please give sufficient detail to diagnose. Information such as other equipment in the station, meter readings and anything else you feel might be useful in attempting diagnosis.

Caution: _____

Do not pack the equipment in crushed newspapers for shipment. Extensive damage may result during shipment.

Notes: _____

1. Record the date of purchase, serial number and dealer from whom purchased.
2. For your own information, retain a written record of any maintenance performed on the unit.
3. When claiming warranty service, please include a photocopy of the bill of sale, or other proof of purchase showing the date of sale must accompany the transceiver.

6-3. IN CASE OF DIFFICULTY

The problems described in this table are failures caused, in general, by improper operation or connection of the transceiver, not by defective components. Examine and check according to the following table.

Symptom	Probable cause	Corrective action
Indicators do not light and no receiver noise is heard when the POWER switch is turned on.	1. Bad power cable or connections. 2. Blown power supply fuse.	1. Check cables and connections. 2. Check for the cause of the blown fuse and replace the fuse.
No sound from the speaker. No signal can be received.	1. Squelch is closed. 2. With the TSU-6: CTCSS is operating.	1. Turn the SQL control counterclockwise. 2. Press the TONE/T.ALT key to turn off the CTCSS.
No transmitter output.	1. Microphone jack is not plugged in. 2. Poor antenna connection.	1. Plug jack in. 2. Connect antenna securely.
Weak signal cannot be received.	Poor antenna connection.	Connect antenna securely.
Display is dark.	1. Power voltage is low. 2. The DIM key had been pressed.	1. Check voltage for 13.8 VDC \pm 15%. 2. Press the F key and the LOW/DIM key.
No control works.	LOCK is ON.	Set the Microphone Lock key to OFF position.
Memory cannot be backed up.	Backup battery voltage is low.	See Microprocessor memory back-up page 21.

7. OPTIONAL ACCESSORIES

7-1-1. CTCSS unit TSU-6

The use of the optional sub-audible tone decoder TSU-6 allows for CTCSS Tone Squelch operation. When this option is active squelch will only open when the proper tone is received.

Installation

Caution:

Before installation be sure to disconnect the DC power supply, or battery or damage may occur to the equipment.

1. Remove the 2 screws securing the Top cover.
2. Gently remove the top cover. (Fig. 1)
3. Remove the backing from the small cushion provided with the TSU-6 and attach it to the back of the TSU-6 as shown in Fig. 2.
4. Attach the cable to the TSU-6 as shown in Fig. 2.
5. Remove the backing from the other side of the small cushion and attach the TSU-6 to the transceiver as shown.

Note:

If you are installing the DRU-1 attach the TSU-6 to the DRU-1 as shown in Fig. 3.

6. Replace the cover and tighten the screws to complete the installation.

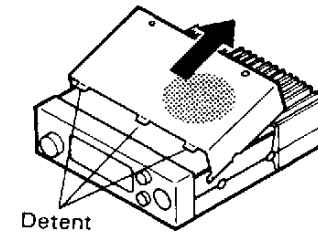

Fig. 1

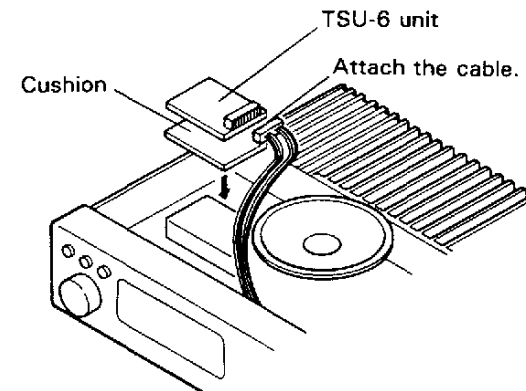

Fig. 2

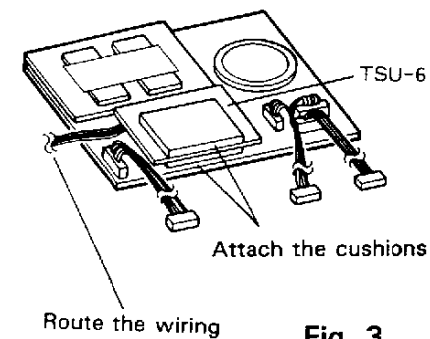

Fig. 3

7-1-2. Digital Recording Unit DRU-1

1. Remove the 2 screws securing the Top cover. Gently remove the top cover. (Fig. 1)
2. Attach the three cables from the DRU-1 as shown in Fig. 2.
3. Gently place the DRU-1 in the transceiver as shown in Fig. 3. Don't forget to attach the TSU-6 as shown if you are installing this unit at the same time (Fig. 4). Tighten the screw.
4. Replace the covers and tighten the screws to complete the installation.

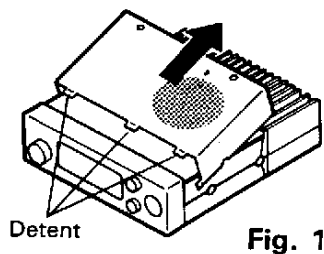

Fig. 1

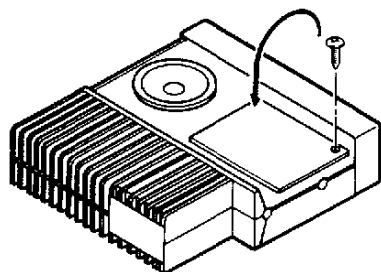

Fig. 3

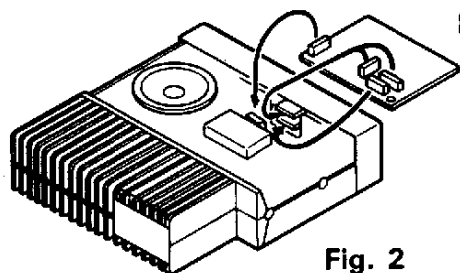

Fig. 2

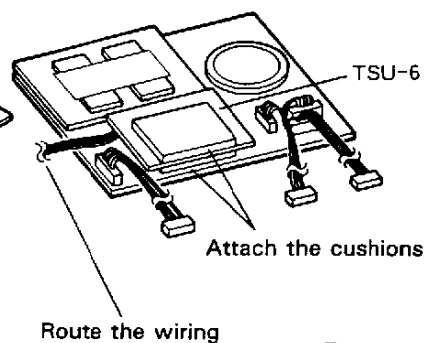

Fig. 4

7-1-3. Remote Controller RC-10

To operate the transceiver with the RC-10 press and hold the CALL key on the transceiver and then turn on the POWER switch.

To select the CALL channel when using the RC-10 press the F key on the RC-10 and then the VFO key.

Please refer to the instructions provided with the RC-10 for a description of the other RC-10 functions.

7-2. ACCESSORIES

■ MC-44/MC-44E (E: European Version) MULTI FUNCTION MICROPHONE



■ MC-60A MICROPHONE (8-pin)

The zinc die-cast base provides high stability. The MC-60A is complete with PTT and LOCK switches, UP/DOWN switches, impedance selector switch and a built-in pre-amplifier.



■ SP-41 MOBILE SPEAKER (4 ohms)

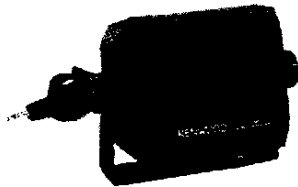

■ MC-44DM/MC-44DME (E: European Version) MULTI FUNCTION MICROPHONE WITH AUTOPATCH



■ MC-80 MICROPHONE (8-pin)

The MC-80 is an omnidirectional electret condenser microphone that is provided with UP/DOWN switches, volume adjustment for output level, PTT and LOCK switches, and a built-in pre-amplifier.



■ SP-50B MOBILE SPEAKER (8 ohms)

Compact and smart, high quality external speaker provides flexibility of installation for maximum convenience.



■ MC-55 MOBILE MICROPHONE (8-pin)

The MC-55 provides UP/DOWN switches, LED display for switching transmit or receive, adjustable microphone gain, automatic timeout circuit (approx. 5 minutes) and many other functions.



■ MC-85 MICROPHONE (8-pin)

The MC-85 is a unidirectional high-class electret condenser microphone provided with an output selector switch, audio level compensation circuit, low cut filter, level meter, PTT and LOCK switches.



■ SP-430 EXTERNAL SPEAKER

The SP-430 is an attractive, compact external speaker. This low-distortion speaker provides clear reproduction of the high-quality audio obtained from the transceiver.

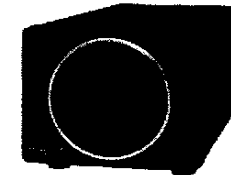

NOTE: 1750 Hz repeater access tone is only available from MC-44E or MC-44DME European version microphone.

■ CTCSS UNIT
TSU-6

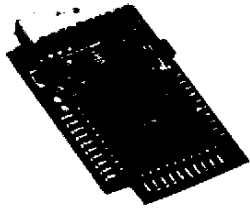

■ PG-3B DC LINE
NOISE FILTER



■ PG-2N DC POWER CABLE

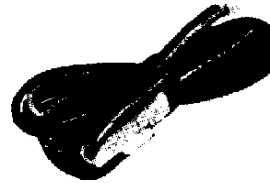

■ RC-10 REMOTE CONTROLLER



■ DIGITAL RECORDING UNIT
DRU-1

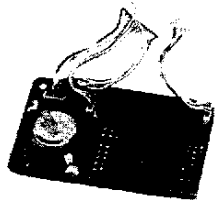

■ RC-20
REMOTE CONTROLLER



■ IF-20 INTERFACE

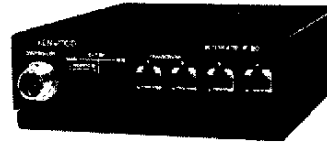

■ PG-4J
EXTENSION
CABLE KIT



■ PG-4H INTERFACE
CONNECTING CABLE



■ MB-201 MOBILE MOUNTING
BRACKET



■ PS-31
DC POWER SUPPLY

■ PS-430 DC POWER SUPPLY

■ PS-50 HEAVY DUTY
DC POWER SUPPLY

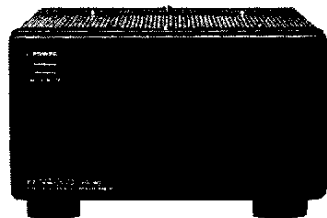

For Example

