

ICOM

INSTRUCTION MANUAL

VHF AIR BAND TRANSCEIVER

IC-A20

Icom Inc.

www.r6-ru4montesecchieta.it

IZ5CCV

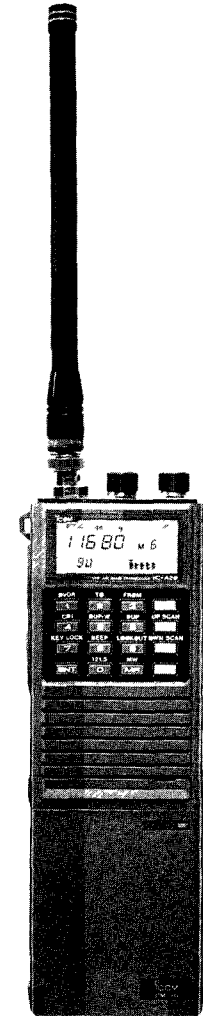

FOREWORD

Thank you for choosing the **IC-A20 VHF AIR BAND TRANSCEIVER**. The **IC-A20** is designed with the latest computer technology and precision VHF engineering at ICOM, and has the following advanced features:

- VOR reception for navigation systems
- Weatherproof and dust-tight case with molded frame design
- 5W PEP (typical) output power
- 16 user-programmable memory channels
- 720 COM channels and 200 NAV channels

Please read this owner's manual carefully before using your **IC-A20** transceiver. With proper care, the **IC-A20** will provide years of dependable and enjoyable communication.

UNPACKING

Accessories	Qty.
✓ ① CM-7G BATTERY PACK . . .	1
✓ ② CM-16U WALL CHARGER . .	1
✓ ③ Flexible antenna	1
✓ ④ Rainproof cap	1
⑤ DC power plug	1
⑥ Microphone plug	1
⑦ Earphone plug	1
✓ ⑧ Belt clip mounting screws	2
✓ ⑨ Belt clip mounting washers	2
⑩ IC-CM1 CIGARETTE LIGHTER CABLE	1
✓ ⑪ Belt clip	1
✓ ⑫ Earphone	1
✓ ⑬ Carrying case	1

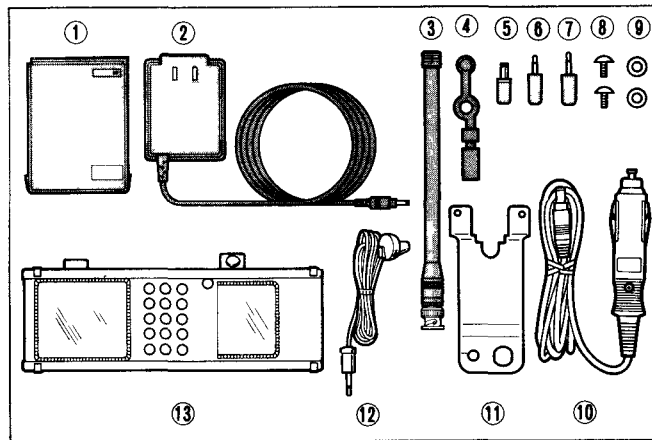
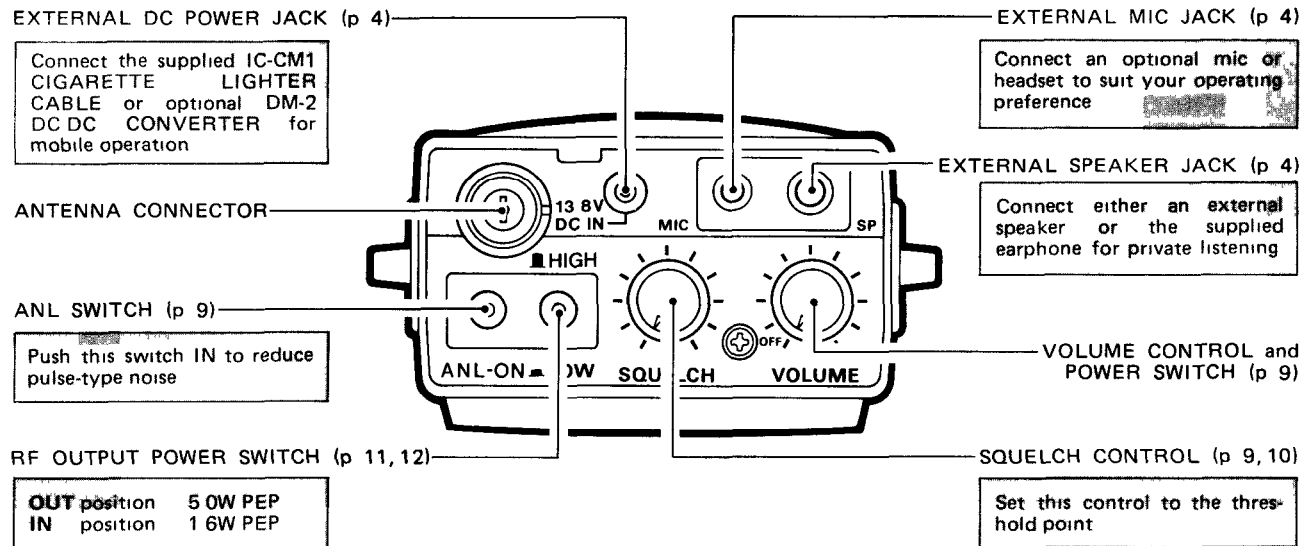

TABLE OF CONTENTS

1. CONTROL FUNCTIONS.....	1 ~ 3	5. SCANNING OPERATION.....	15 ~ 18
TOP PANEL.....	1	OPERATING FULL SCAN.....	15
SIDE PANEL.....	2	OPERATING MEMORY SCAN.....	16
FRONT PANEL.....	2	OPERATING LOCKOUT SCAN.....	17
FUNCTION DISPLAY.....	3		
2. PRE-OPERATION.....	4 ~ 6	6. DUPLEX OPERATION.....	19 ~ 20
OPERATING CONNECTIONS.....	4	PROGRAMMING DUPLEX MODE.....	19
CHARGING CONNECTIONS.....	5	OPERATING DUPLEX MODE.....	20
BATTERY CHARGING.....	6		
3. BASIC OPERATION.....	7 ~ 12	7. VOR NAVIGATION.....	21 ~ 26
SETTING FREQUENCY.....	7	VOR INDICATORS.....	21
RECEIVING.....	9	FLYING TO A VOR STATION.....	23
TRANSMITTING.....	11	CROSSCHECKING POSITION.....	25
		VOR INDICATOR NOTE.....	25
4. MEMORY CHANNEL		8. OTHER FUNCTIONS.....	27 ~ 28
OPERATION.....	13 ~ 14	KEY LOCK FUNCTION.....	27
RECALLING A MEMORY CHANNEL.....	13	BEEP TONE FUNCTION.....	27
PROGRAMMING A MEMORY CHANNEL..	13	RESETTING MICROPROCESSOR.....	27
		9. OPTIONS.....	29 ~ 30
		10. SPECIFICATIONS.....	31

1. CONTROL FUNCTIONS

TOP PANEL



SIDE PANEL

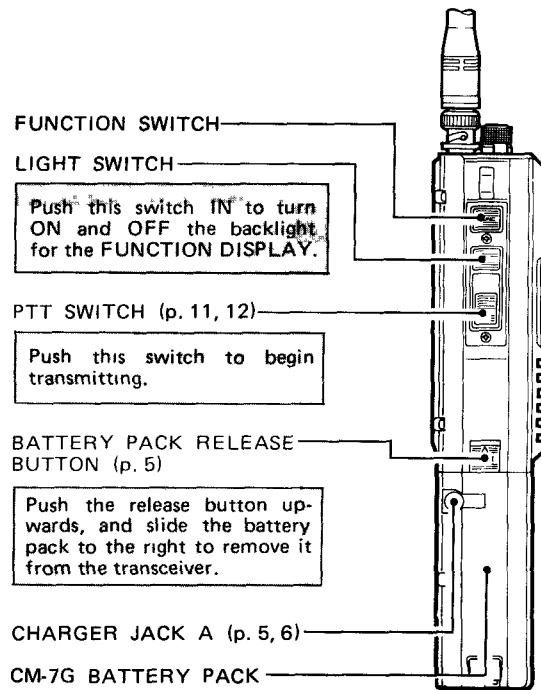

FRONT PANEL

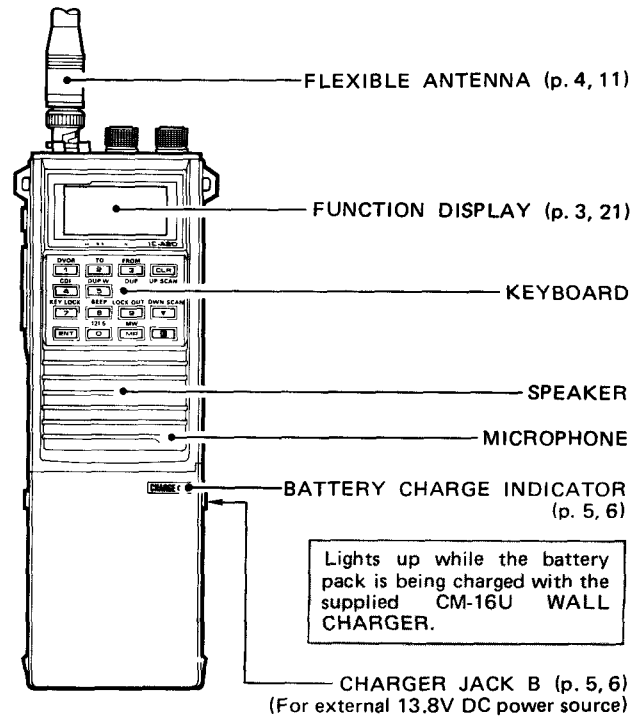

FUNCTION DISPLAY

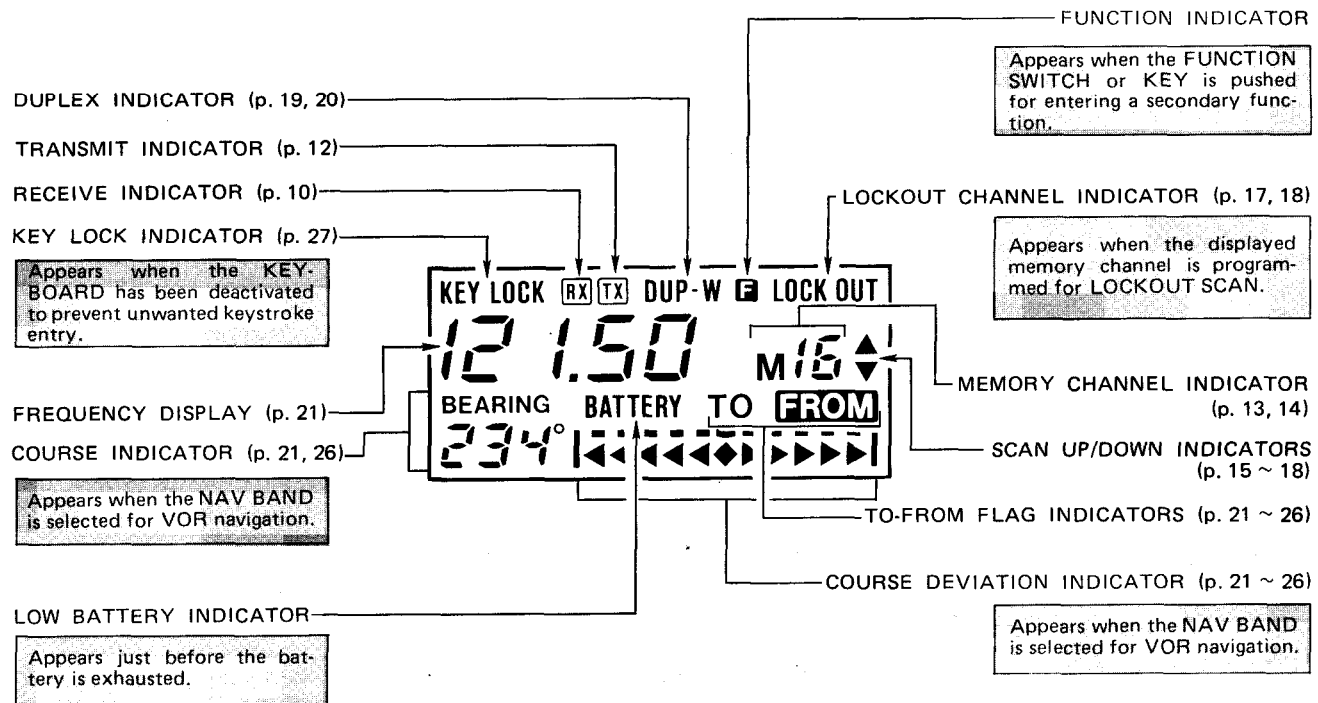

2. PRE-OPERATION

OPERATING CONNECTIONS

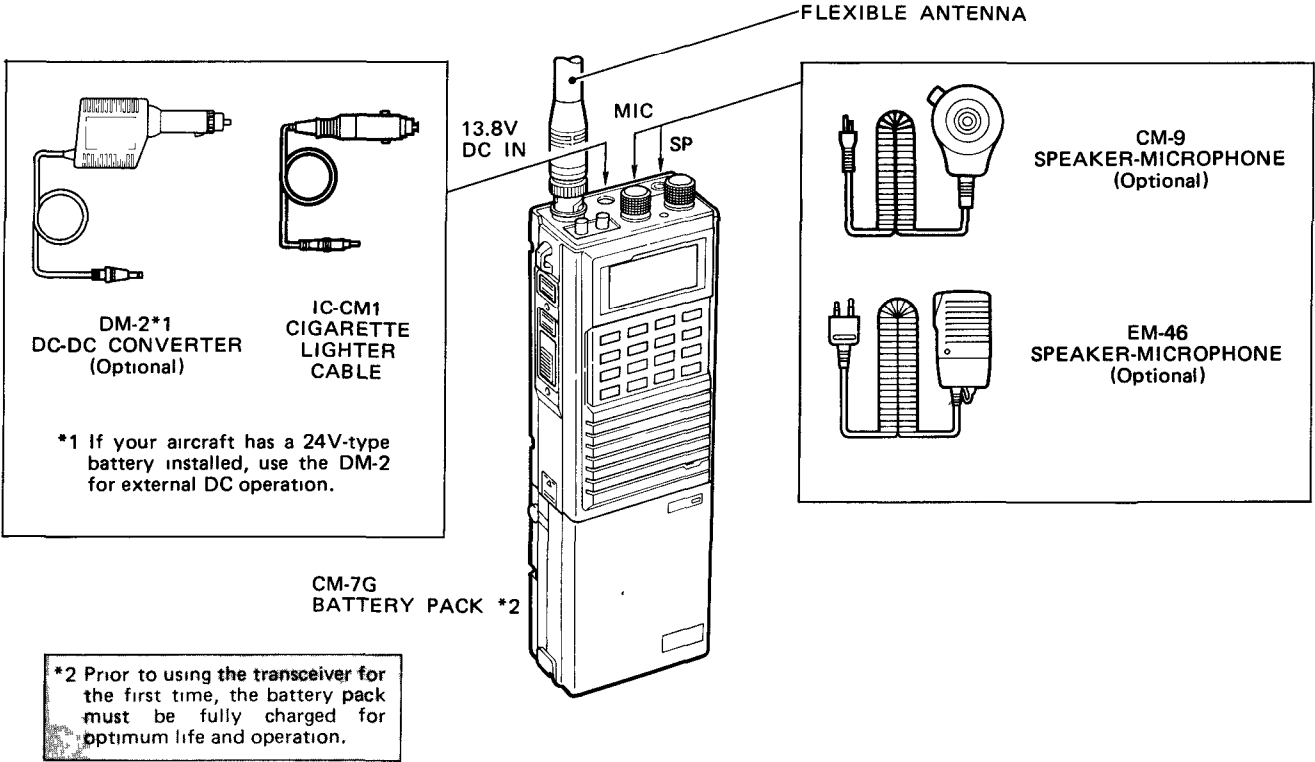

CHARGING CONNECTIONS

• Removing the battery pack

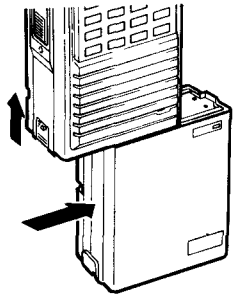

Push the release button upwards, and slide the battery pack to the right to remove it from the transceiver

*2 The CM-60A AC BATTERY CHARGER for multiple, simultaneous charging of up to six battery packs is also available.

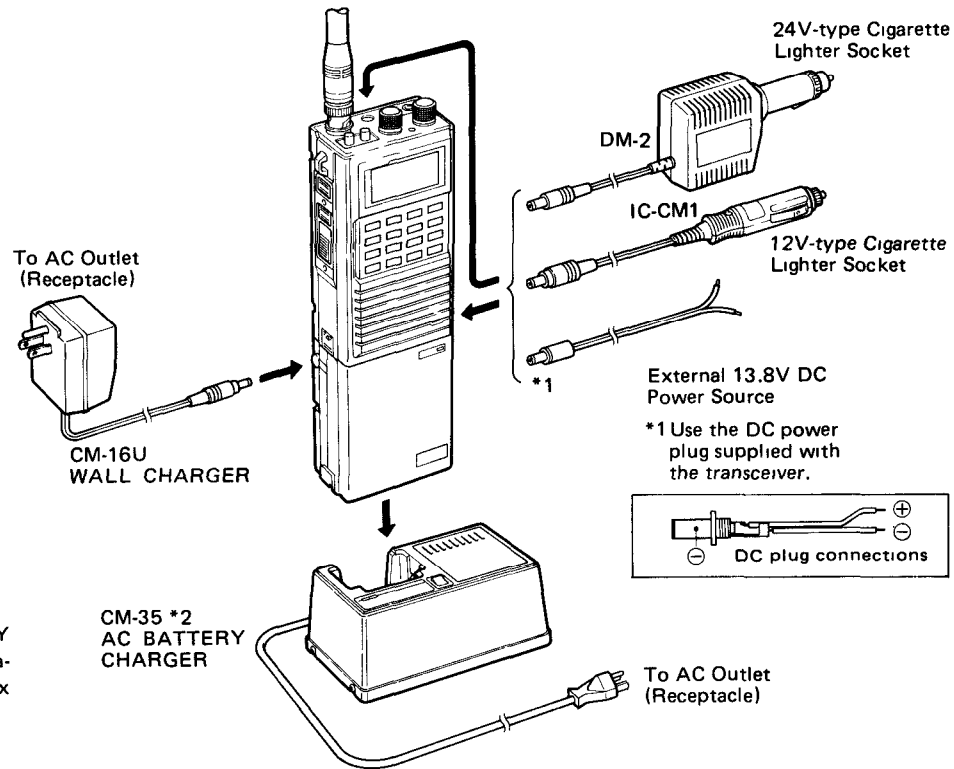

BATTERY CHARGING

■ USING THE CM-16U WALL CHARGER

Prior to using the transceiver for the first time, the battery pack must be fully charged for optimum life and operation.

- 1) Connect the supplied CM-16U WALL CHARGER.
- 2) Charge the battery pack for about 15 hours.
 - The BATTERY CHARGE INDICATOR lights up while charging.
 - The battery pack need not be installed on the transceiver for charging. However, if it is, be sure to turn the transceiver OFF.

■ USING OTHER CHARGERS

CHARGER MODEL	CM-35	IC-CM1, DM-2
CHARGE TIME	1.5 hours	15 hours

■ BATTERY PACK NOTE

The full charge capacity of NiCd batteries may be reduced if repeatedly charged with only partial discharge periods. This is called the Battery Memory Effect. If the battery capacity seems lower than when new, discharge the battery pack completely through normal use, then charge fully using the proper charger.

■ BATTERY PACK CAUTIONS

- **NEVER** throw the battery pack into a fire since internal battery gas could cause an explosion.
- **NEVER** put the battery pack in water. If the battery pack is wet, be sure to wipe it dry.
- **NEVER** short the terminals on the top panel of the battery pack. Use the plastic insulator strip provided to prevent this.

3. BASIC OPERATION

SETTING FREQUENCY

■ RECALLING THE EMERGENCY FREQUENCY

(See EXAMPLE 1)

The IC-A20 can quickly recall the emergency frequency, 121.5MHz.

- 1) Turn power ON.
- 2) Push either the **[FUNC]** SWITCH on the side panel or **[E]** KEY on the KEYBOARD.
- 3) Push the **[G]** KEY on the KEYBOARD.
 - "121.50" and "M" appear on the FUNCTION DISPLAY.
- 4) Push the **[CLR]** KEY to return to NORMAL MODE.

■ USING **[▲]** AND **[▼]** KEYS

(See EXAMPLE 2)

- 1) Turn power ON.
- 2) Push either the **[▲]** or **[▼]** KEY on the KEYBOARD to change the frequency by 25kHz steps.

■ USING NUMERICAL KEYS

(See EXAMPLE 3)

- 1) Turn power ON.
- 2) Push the desired numerical keys for setting the frequency then push the **[ENT]** KEY.
 - The frequency should be entered from the 10MHz digit.
 - The decimal point appears on the FUNCTION DISPLAY if the frequency is set completely.

EXAMPLE 1: Recalling the emergency frequency, 121.5MHz.

Push keys



Display

123.65

123.65⁰

121.50 M

123.65

EXAMPLE 2: Changing frequency using the ▲ and ▼ keys.

Push keys



Display

123.65

123.675

123.65

123.625

EXAMPLE 3: Setting frequency for 118.20MHz using the numerical keys.

Push keys



Display

123.625

118

118.20

118.20

RECEIVING

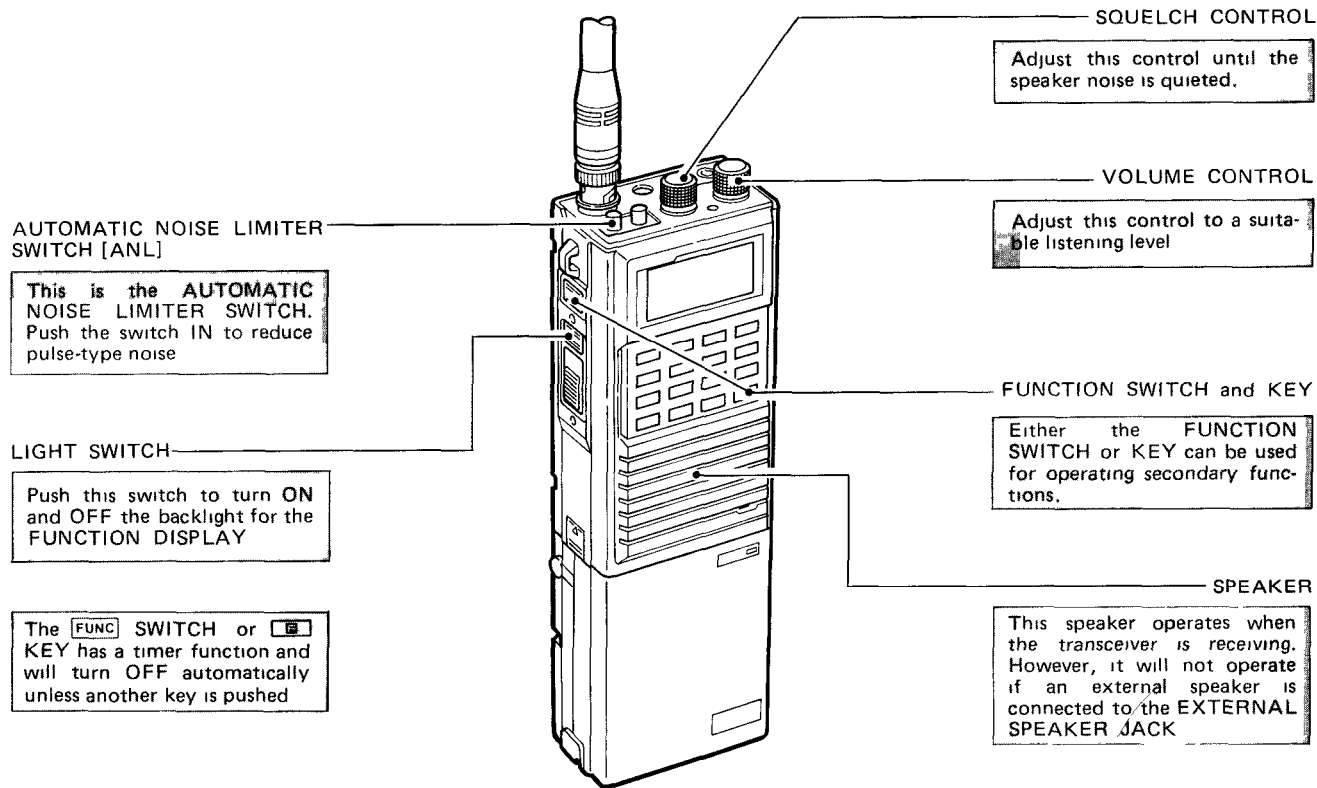

1) Turn power ON.

2) Set the desired frequency.

3) Adjust [VOLUME] CONTROL.

4) Adjust [SQUELCH] CONTROL.

5) Push IN [ANL] SWITCH.

6) "RX" appears.

1) Turn the transceiver power ON.

2) Set the desired frequency. (See page 7)

- Receive frequency range: 108.000 ~ 135.975MHz

3) Adjust the [VOLUME] CONTROL to a suitable listening level.

4) Adjust the [SQUELCH] CONTROL until the speaker noise is quieted.

- "RX" disappears from the FUNCTION DISPLAY.

SQUELCH: If closed, the squelch mutes all noise from the speaker when no signal is received. This is useful while waiting for another station to call.

5) Push IN the AUTOMATIC NOISE LIMITER [ANL] SWITCH to reduce pulse-type noise such as that caused by engine ignition systems.

NOTE: The ANL function does not function in NAV BAND (108.000 ~ 117.975MHz) since VOR navigation errors could occur.

6) "RX" appears on the FUNCTION DISPLAY when the transceiver receives a signal.

TRANSMITTING

FLEXIBLE ANTENNA

CAUTION:
Transmitting without an antenna may damage the transceiver.

LIGHT SWITCH

Push this switch to turn ON and OFF the backlight for the FUNCTION DISPLAY.

PTT SWITCH

Push this switch to begin transmitting.

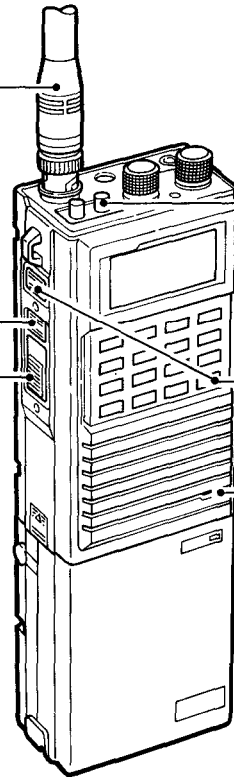

The **FUNC SWITCH** or **KEY** has a timer function and will turn OFF automatically unless another key is pushed.

RF OUTPUT POWER SWITCH

OUT position : 5.0W PEP
IN position : 1.6W PEP

FUNCTION SWITCH and KEY

Either the **FUNCTION SWITCH** or **KEY** can be used for operating secondary functions.

MICROPHONE

This microphone operates when the transceiver is transmitting. However, it will not operate if an external microphone is connected to the **EXTERNAL MICROPHONE JACK**.

NOTE: Listen carefully before transmitting to make sure your transmission will not interfere with any other communications.

See page 19 for duplex operation instructions using NAV BAND and COM BAND.

- 1) Set the desired frequency.
 - 1) Set the desired frequency in COM BAND. (See page 7)
 - Transmitting in NAV BAND is not permitted.
 - COM BAND frequency range: 118.000 ~ 135.975MHz.
- 2) Select output power.
 - 2) Select output power using the RF OUTPUT POWER SWITCH.
 - **HIGH power** : Greater coverage for long distance transmissions.
 - **LOW power** : Low output power conserving battery life.
- 3) Push [PTT] SWITCH.
 - 3) Push the [PTT] SWITCH to begin transmitting. Speak into the microphone using your normal voice level.
 - "[TX]" appears on the FUNCTION DISPLAY while transmitting.
- 4) Release [PTT] SWITCH.
 - 4) Release the [PTT] SWITCH to return to receiving.

4. MEMORY CHANNEL OPERATION

RECALLING A MEMORY CHANNEL

- 1) Push **MR** KEY.
 - 2) Enter a memory channel number
 - 3) Push **CLR** or **MR** KEY.
- 1) Push the **MR** KEY to select MEMORY CHANNEL MODE.
 - 2) The following two methods are available to select the desired memory channel.
 - Push either the **▲** or **▼** KEY. Move through memory channels continuously by holding down either the **▲** or **▼** KEY.
 - Push keys for a desired memory channel number from 1 to 16 then push the **ENT** KEY. (See **EXAMPLE 5**)
 - 3) Push the **CLR** or **MR** KEY to return to NORMAL MODE.

PROGRAMMING A MEMORY CHANNEL

- 1) Set NORMAL MODE.
 - 2) Set the desired frequency
 - 3) Push **F** KEY then push **MR** KEY.
 - 4) Push the desired memory channel number then push **ENT** KEY.
- 1) Set the NORMAL MODE. (See **EXAMPLE 4**)
 - 2) Set the desired frequency using the **▲** or **▼** KEY or numerical keys. (See **page 7**)
 - 3) Push the **F** KEY then push the **MR** KEY.
 - To cancel the programming memory channel, push the **F** KEY then push the **CLR** KEY.
 - 4) Push keys for a desired memory channel number from 1 to 16 then push the **ENT** KEY.

EXAMPLE 4: Selecting the NORMAL MODE and MEMORY CHANNEL MODE.

Push keys

MR **MR** or **CLR**

Display

118.20 124.65 M I 118.20

EXAMPLE 5: Recalling memory channel 16 using the numerical keys.

Push keys

MR **1** **6** **ENT** **MR** or **CLR**

Display

124.65 M I 124.65 M I ↕ 124.65 M I 6 ↕ 122.50 M I 6 118.20

EXAMPLE 6: Programming 118.20MHz in memory channel 16.

Push keys

(See frequency) **F** **MR** **1** **6** **ENT**

Display

121.60 118.20 118.20* 5 ↕ 118.20* 16 ↕ 118.20

5. SCANNING OPERATION

NOTE: Push the **[CLR]** KEY to indicate the course indicator when the scan stops on a VOR frequency while in MEMORY SCAN

OPERATING FULL SCAN

- 1) Select NORMAL MODE.
- 2) Adjust [SQUELCH] CONTROL.
- 3) Push **[E]** KEY then h **[▲]** or **[▼]** KEY.
- 4) Push **[CLR]** KEY.

The IC-A20 comes equipped with three scan functions, providing tremendous scanning versatility at the touch of just a few keys.

SCAN TYPE	OPERATION
FULL SCAN	Scans full COM BAND frequency range 118 ~ 135.975MHz.
MEMORY SCAN	Scans all memory channels, 1 ~ 16.
LOCKOUT SCAN	Scans all memory channels while skipping locked out memory channels.

(See EXAMPLE 7)

- 1) Select NORMAL MODE. (See EXAMPLE 4)
- 2) Adjust the [SQUELCH] CONTROL to set the transceiver for scan operations.
 - “**[RX]**” disappears from the FUNCTION DISPLAY.
- 3) Push the **[E]** KEY then push either the **[▲]** or **[▼]** KEY to start the scan.
 - The decimal point blinks while in scanning operation.
 - The scan stops while receiving the signal. The scan resumes after the signal disappears.
- 4) Push the **[CLR]** KEY to cancel the scan.

OPERATING MEMORY SCAN

(See EXAMPLE 8)

- 1) Push **[MR]** KEY.
 - 2) Adjust [SQUELCH] CONTROL.
 - 3) Push **[F]** KEY then push **[▲]** or **[▼]** KEY.
 - 4) Push **[CLR]** KEY.
- 1) Push the **[MR]** KEY to select MEMORY CHANNEL MODE.
 - 2) Adjust the [SQUELCH] CONTROL to set the transceiver for scan operations.
 - “**[RX]**” disappears from the FUNCTION DISPLAY.
 - 3) Push the **[F]** KEY then push either the **[▲]** or **[▼]** KEY to start the scan.
 - The decimal point blinks while in scanning operation.
 - The scan stops while receiving the signal. The scan resumes after the signal disappears.
 - 4) Push the **[CLR]** KEY to cancel the scan.

EXAMPLE 7: Operating FULL SCAN in an upwards direction.

Push keys

Display

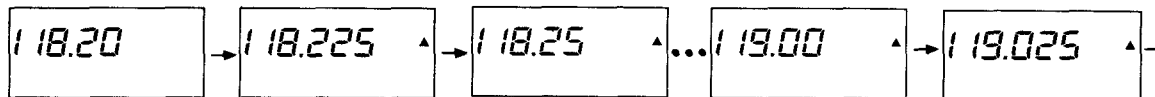

OPERATING LOCKOUT SCAN

■ PROGRAMMING LOCKOUT CHANNEL

(See EXAMPLE 9)

- 1) Push **[MR]** KEY.
- 2) Select the desired memory channel.
- 3) Push **[P]** KEY then push **[S]** KEY.
- 4) Push **[CLR]** KEY.
- 1) Push the **[MR]** KEY to select MEMORY CHANNEL MODE.
- 2) Push keys for a memory channel you do not want to receive in while scanning then push the **[ENT]** KEY. (See page 13)
- 3) Push the **[P]** KEY then push the **[S]** KEY.
- 4) Push the **[CLR]** KEY to return to NORMAL MODE.

■ OPERATING LOCKOUT SCAN

(See EXAMPLE 10)

- 1) Push **[MR]** KEY.
- 2) Adjust [SQUELCH] CONTROL.
- 3) Push **[P]** KEY then push **[▲]** or **[▼]** KEY.
- 4) Push **[CLR]** KEY.
- 1) Push the **[MR]** KEY to select MEMORY CHANNEL MODE.
- 2) Adjust the [SQUELCH] CONTROL to set the transceiver for scan operations.
- 3) Push the **[P]** KEY then push either the **[▲]** or **[▼]** KEY to start the scan.
 - The decimal point blinks while in scanning operation.
 - The scan stops while receiving the signal. The scan resumes after the signal disappears.
- 4) Push the **[CLR]** KEY to cancel the scan.

EXAMPLE 8: Operating MEMORY SCAN in a downwards direction.

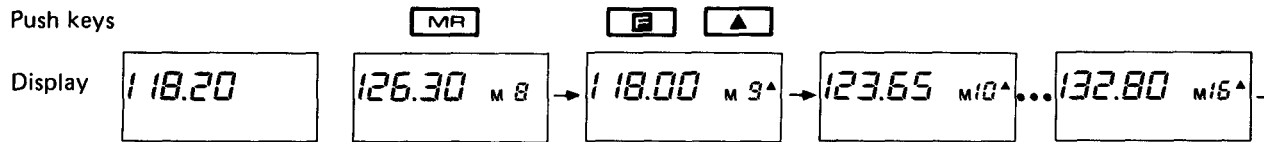

EXAMPLE 9: Programming the lockout channel on memory channel 8.

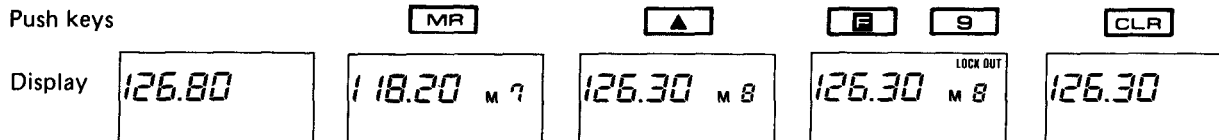

EXAMPLE 10: Operating LOCKOUT SCAN in an upwards direction.

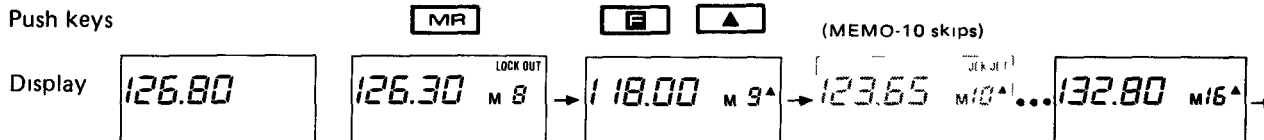

6. DUPLEX OPERATION

PROGRAMMING DUPLEX MODE

NOTE: To cancel the programming duplex mode, push the **[F]** KEY then push the **[CLR]** KEY

- 1) Set a NAV frequency.
- 2) Push the **[F]** KEY then push the **[5]** KEY.
- 3) Set the desired transmit frequency on COM BAND then push the **[ENT]** KEY.
 - The transmit frequency is stored. (See **EXAMPLE 11**)
- 4) The duplex condition can be programmed in memory channels in which the NAV frequency is programmed. (See **EXAMPLE 12**)

EXAMPLE 11: Programming 121.20MHz for transmit frequency in DUPLEX MODE.

Push keys **[F]** **[5]** **[2]** **[1]** **[2]** **[0]** **[ENT]**

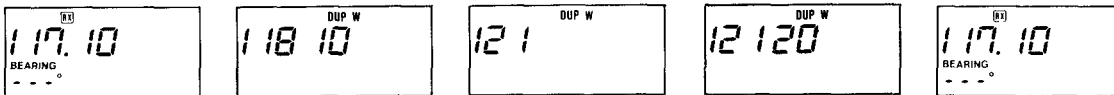

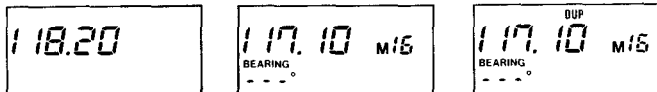

Display 

EXAMPLE 12: Programming the duplex condition in memory channel 16 in which 117.10MHz has already been programmed.

Push keys **[MR]** **[F]** **[6]**

Display 

OPERATING DUPLEX MODE

- 1) Set a NAV or VOR frequency you want to receive in.
- 2) Push the  KEY then push the  KEY.
- 3) Push the [PTT] SWITCH to transmit.
 - “TX” appears and the displayed frequency is changed to the programmed transmit frequency.
- 4) Push the  KEY then push the  KEY again to turn DUPLEX MODE ON and OFF alternately. (See EXAMPLE 14)

EXAMPLE 13: Operating DUPLEX MODE on a NAV frequency of 117.10MHz and a transmit COM frequency of 121.20MHz.

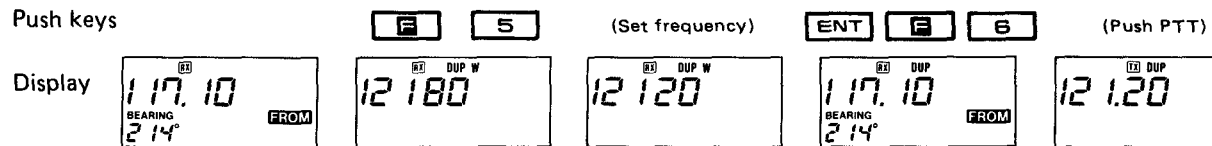

EXAMPLE 14: Turning DUPLEX MODE ON and OFF.

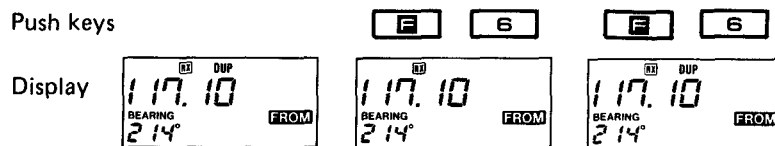

7. VOR NAVIGATION

VOR INDICATORS

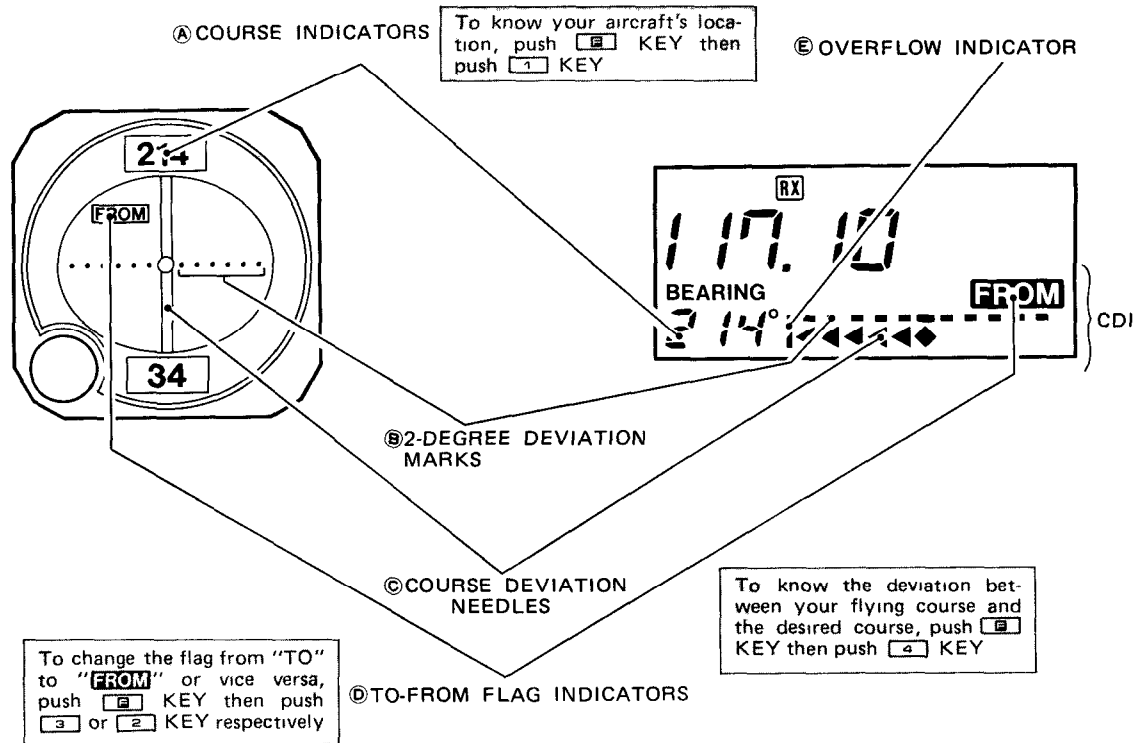

Ⓐ COURSE INDICATOR

Indicates where your aircraft is located on a VOR radial.

- "OFF" or "---" appear when your aircraft is too far from a VOR station or a frequency is not set correctly.

CAUTION: Measuring error of the course may occur by a maximum of 5°.

Ⓑ 2-DEGREE DEVIATION MARKS

Indicates course deviation by every 2 degrees.

Ⓒ COURSE DEVIATION NEEDLES

Indicates the deviation between the desired course and your actual flying course by every 2 degrees of deviation.

Ⓓ TO-FROM FLAG INDICATORS

Indicates whether the entered course is on line toward a VOR station or away from a VOR station.

Ⓔ OVERFLOW INDICATOR

Indicates if the deviation between the desired course and flying course is more than 10° degrees.

EXAMPLE 15: Changing the FLAG INDICATOR from "TO" to "FROM", or vice versa.

Push keys



Display

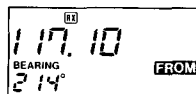
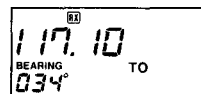
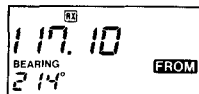

FLYING TO A VOR STATION

1) Select a VOR station on your map.

2) Correct your aircraft heading.

3) Push **[F]** KEY then push **[4]** KEY.

4) Enter the desired course.

NOTE: To exit CDI MODE, access DVOR MODE and then access NORMAL MODE.

Example: Push the **[F]** KEY then push the **[4]** KEY.

5) Correct the desired course

1) Select a VOR station on your map and set the frequency of the station.

- The COURSE INDICATOR indicates where you are located on a VOR radial from a VOR station.

2) Correct your aircraft heading using the COURSE INDICATOR number.

3) Push the **[F]** KEY then push the **[4]** KEY to indicate the COURSE DEVIATION INDICATOR (CDI).

4) Enter the desired course to the VOR station using numerical keys then push the **[ENT]** KEY.

- "▶▶▶▶" appears on the FUNCTION DISPLAY when your aircraft is off the desired course. (See Figure 2)
- The CDI indicates "FFF" when your aircraft is too far away from a VOR station, or the frequency is not set correctly at a VOR station.

5) When flying to a VOR station, or flying away from a VOR station, the CDI deviates to the right side of the display to show that the aircraft is off course to the left.

- To get back on course, turn your aircraft to the right until the CDI stops indicating deviation.

■ THE AIRCRAFT IS FLYING ON COURSE

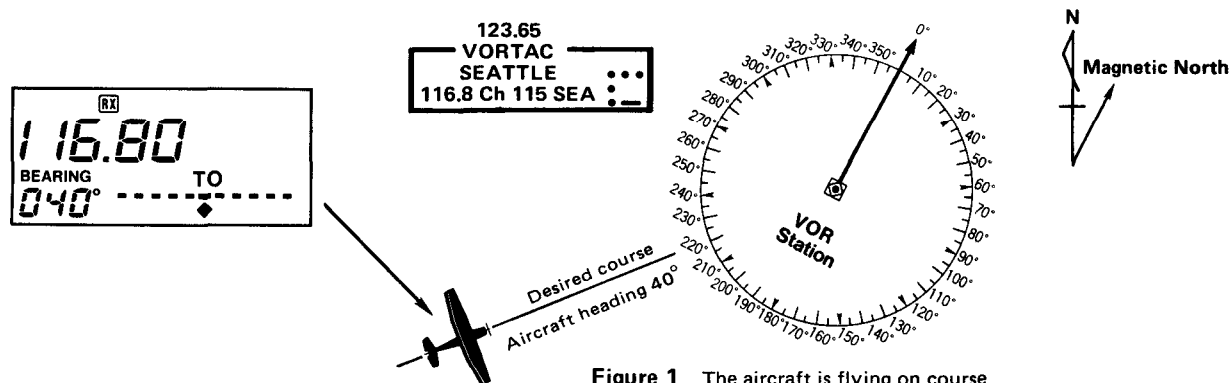

Figure 1 The aircraft is flying on course

■ THE AIRCRAFT IS FLYING OFF COURSE

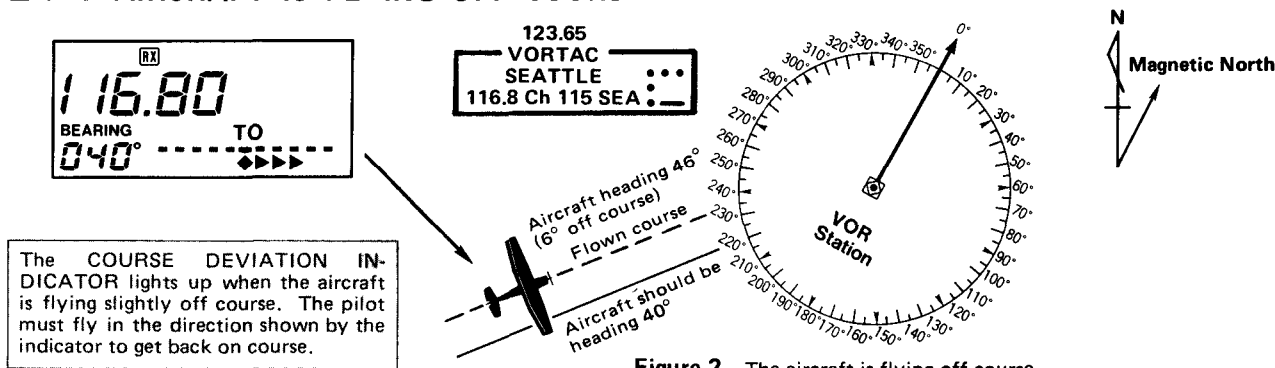
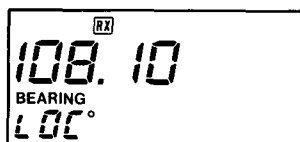

Figure 2 The aircraft is flying off course

CROSSCHECKING POSITION

- 1) Select two VOR stations on your map.
 - 2) Set a frequency of one VOR station.
 - 3) Set the other frequency of a VOR station.
 - 4) Extend both the radials.
- 1) Select two VOR stations on your map.
 - 2) Set a frequency of one VOR station.
 - The COURSE INDICATOR lights up and indicates which VOR radial from the VOR station the aircraft is flying on. Note the number of the COURSE INDICATOR.
 - 3) Set the other frequency of a VOR station.
 - The COURSE INDICATOR lights up and indicates which VOR radial from the VOR station the aircraft is flying on. Note the number of the COURSE INDICATOR.
 - 4) Extend the radials from each VOR station on your map. Your aircraft is located in the spot where both the lines cross each other. (See Figure 3)

VOR INDICATOR NOTE



"**LOC**" appears on the FUNCTION DISPLAY as shown at left when a localizer frequency is received by the IC-A20.

However, the FUNCTION DISPLAY does not indicate additional information about the localizer signal.

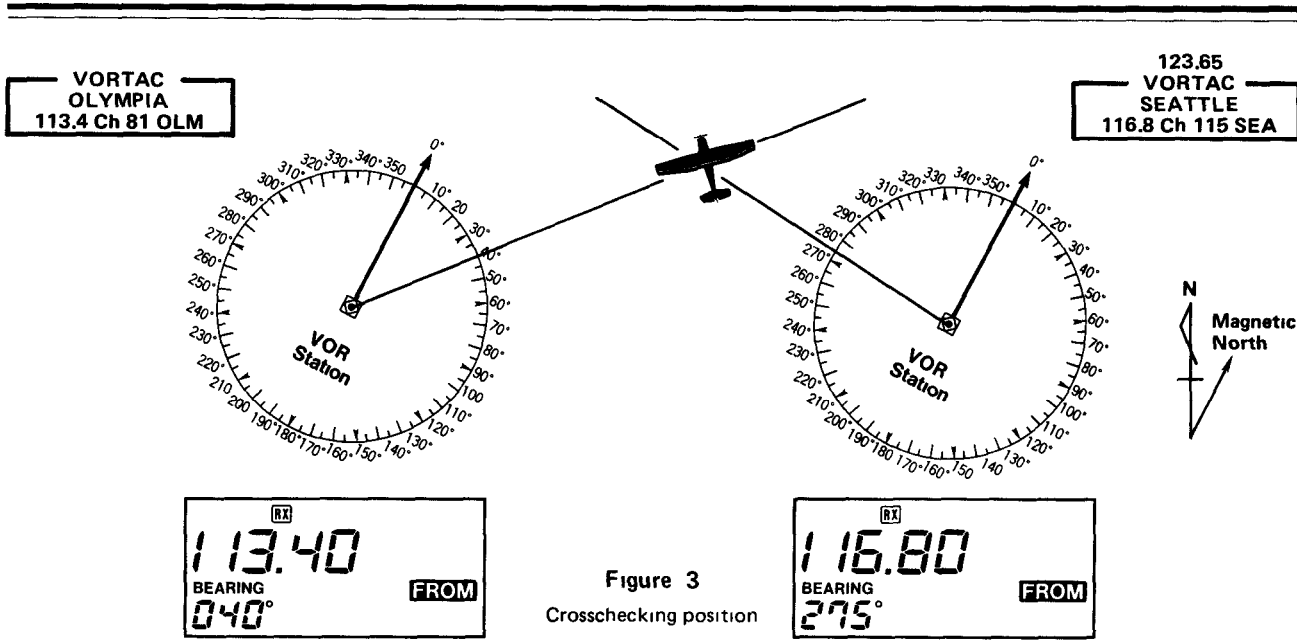

Figure 3
Crosschecking position

EXAMPLE 16: Entering the desired course bearing 89° to a VOR station.

Push keys





Display

	[F] 2	[F] 4	8 9	[ENT]
116.80 BEARING 275° FROM	116.80 BEARING 095° TO	116.80 BEARING 095° TO	116.80 BEARING 089° TO	116.80 BEARING 089° TO

8. OTHER FUNCTIONS



KEY LOCK FUNCTION

This feature prevents accidental changes of the operating frequency or other functions selected from the KEYBOARD.

- 1) Push the  KEY then push the  KEY.
 - "KEY LOCK" appears on the FUNCTION DISPLAY.
- 2) To clear the KEY LOCK FUNCTION, push the  KEY then push the  KEY again.

BEEP TONE FUNCTION

The BEEP TONE FUNCTION provides beep sounds, allowing you to make sure of key entries each time a key is pushed.



- 1) Push the  KEY and then the  KEY to turn the function ON and OFF alternately.
- 2) The volume of the tone can be adjusted by turning the [VOLUME] CONTROL.

RESETTING MICROPROCESSOR

Reset the internal microprocessor:

- when the FUNCTION DISPLAY occasionally displays erroneous information during operation or when first applying power.
- when you want to erase all information in all memory channels.

Reset as follows:

Turn the power ON while pushing down both the  and  KEYS.

EXAMPLE 17: Operating with the KEY LOCK FUNCTION ON and OFF.

Push keys

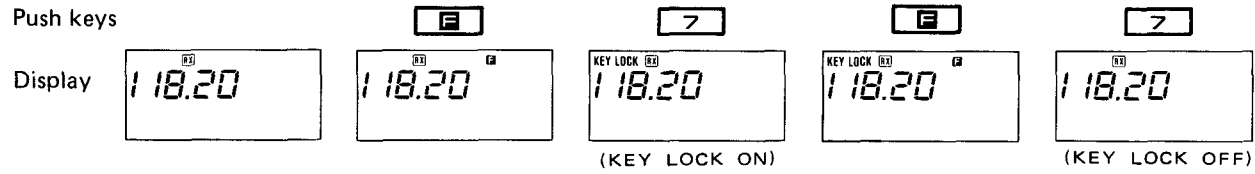

EXAMPLE 18: Operating with the BEEP TONE FUNCTION ON and OFF.

Push keys

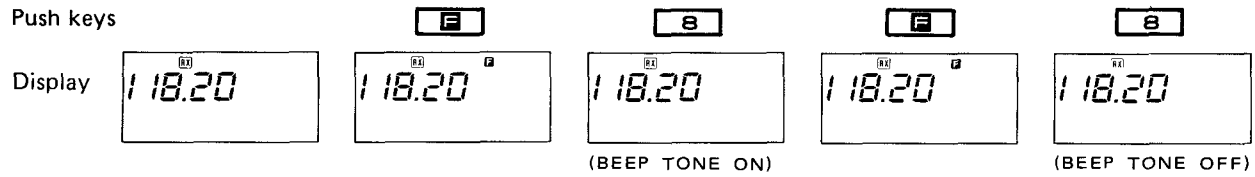

9. OPTIONS

**HS-20SB
PTT SWITCH BOX**

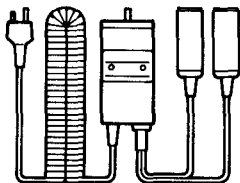

- Manual T/R switching unit for non-ICOM standard headset and mic.

**EM-46
SPEAKER-MICROPHONE**

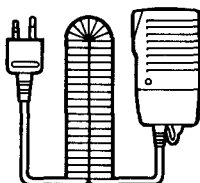

- Combination speaker and microphone in the small body.

**CM-9
SPEAKER-
MICROPHONE**

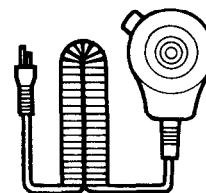

- Combination speaker and microphone.

**CM-60A
MULTI-CHARGER**

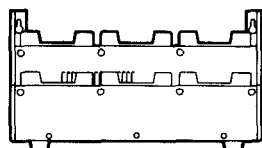

- Charges up to six battery packs simultaneously.

**CM-35
AC BATTERY CHARGER**

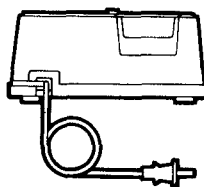

- Charges the supplied battery pack in 1.5 hours.

**DM-2
DC-DC CONVERTER**

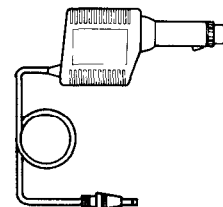

- For operation with a 24V-type external DC power source.

**CM-12G
BATTERY CASE**

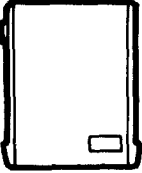

- Output voltage : 15V
Battery : 10 AA size

**CP-10
BATTERY SEPARATION CABLE**

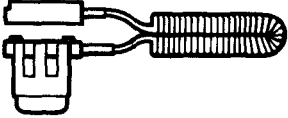

- Handy connector cable for separating the transceiver from the battery pack.

**IC-MB16
MOBILE MOUNTING BRACKET**

- To place your IC-A20 in a convenient location.

**CM-7G
BATTERY PACK**

- An NiCd-type rechargeable battery pack. (Same as the one supplied with the IC-A20.)

HAND STRAP



- Handy hand strap for complete mobility.

SHOULDER STRAP

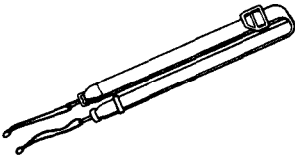

- For transporting your handheld transceiver.

10. SPECIFICATIONS

■ GENERAL

- Memory Channels : 16
- Channel Spacing : 25kHz
- Frequency Stability : 0.002% at $-10^{\circ}\text{C} \sim +50^{\circ}\text{C}$
- Usable Temperature Range : $-10^{\circ}\text{C} \sim +50^{\circ}\text{C}$ ($+14^{\circ}\text{F} \sim +122^{\circ}\text{F}$)
- Dimensions : 65(74)mm(W) x 198(208)mm(H) x 35(42)mm(D)
Bracketed values include projections.
- Weight : 675g (including CM-7G BATTERY PACK and flexible antenna)
- Power Supply : 13.2V DC $\pm 15\%$ (for EXTERNAL DC POWER JACK)

■ RECEIVER

- Frequency Range : 108.000 ~ 135.975MHz
NAV BAND 108.000 ~ 117.975MHz
COM BAND 118.000 ~ 135.975MHz
- Sensitivity (with 50Ω load) : NAV BAND $2\mu\text{V}$ for 6dB S/N with 1kHz, 30% modulation
COM BAND $1\mu\text{V}$ for 6dB S/N with 1kHz, 30% modulation
- Audio Output Power : 0.5W at 10% distortion
- Modulation Acceptance : A3E 6K00 (6A3)

■ TRANSMITTER

- Frequency Range : 118.000 ~ 135.975MHz
- Antenna Output Power : HIGH 5.0W PEP (1.5W carrier power)
(Typical) LOW 1.6W PEP (0.5W carrier power)
Power shows PEP with 85% modulation by a 1kHz audio tone.
- Emission Mode : A3E 6K00 (6A3)
- Modulation System : Low level modulation